

VEICHI

Manual

AC70 Series Frequency Inverter

VEICHI

Shenzhen Veichi Electric Co., Ltd.

Address: Block C, Wentao Science and Technology Park, Shiyan Yingrenshi
Community, Baoan District, Shenzhen, China

Phone: +86-0755-29685610, 29685611, 29685612

Fax: +86-0755-29685615

Suzhou Veichi Electric Equipment Technology Co., Ltd.

Address: No.111 Wusongjiang Avenue, Guoxiang Street, Wuzhong District,
Suzhou, China

Website: www.veichi.com



Version:2016 V1.3
Shenzhen Veichi Electric Co., Ltd all rights
reserved, subject to change without notice.

Contents

Chapter1 Overview	1
1.1 Safety Requirement and Cautions	1
1.2 Technical Criterion	4
Chapter 2 Before Use	7
2.1 Purchase Inspection	7
2.2 Nameplate	7
2.3 Rated Output Current	8
Chapter 3 Installation and Wiring	9
3.1 Safety Precautions	9
3.2 Treatment for Inverter after Longtime Store	9
3.3 Inverter Stable Running Environment	10
3.4 EMI Protection	11
3.5 Machinery Installation	13
3.6 Electric Installation	22
Chapter 4 Basic Operation and Trial Run	37
4.1 Safety Precautions	37
4.2 Keyboard Layout and Function Specification	38
4.3 Basic Operation	40
4.4 Trial Run	45
Chapter 5 Fault Diagnoses and Processing	50
5.1 Fault Types	50
5.2 Fault Information and Details	50
5.3 Fault Diagnoses Process	54
Chapter 6 Periodic Overhaul and Maintenance	60
6.1 Safety Precautions	60
6.2 Overhaul	60
6.3 Maintenance	61
Chapter 7 Peripheral Equipments and Options	64
7.1 Safety Precautions	64
7.2 Peripheral Equipments	64
7.3 The Use of Peripheral Equipments	66
Chapter 8 Function Parameter Specification	69
8.1 Basic Parameters Specification	69
8.2 External Terminal Parameters	93
8.3 .Special Function Parameters	108
Chapter 9 Appendix	119
9.1 Appendix 1: Function Code Simple List	119
9.2 Appendix 2: RS485 Communication Protocol	135
9.3 Appendix 3: LCD Keyboard Manual	141



Operation requirement

Only Professional trained person are allowed to operate the equipment such as installation, wiring, running, maintain and etc. "Professional trained person" in this manual means the workers on this product must experience professional skill train, must be familiar with installation, wiring, running and maintain and can rightly deal with emergency cases in use.



Safety guidance

Safety regulations and warning signs come for your security. They are measures to prevent the operator and machine system from damage. Please carefully read this manual before using and strictly observe the warning signs while operating. Safety regulations and warning signs are classified into: routine regulation, transport and store regulation, installation and wiring regulation, running regulation, maintenance regulation, dismantlement and disposal regulation.

● Routine regulation

	<ul style="list-style-type: none"> ● This product carries dangerous voltage and controls driver machine with potential danger. If you don't abide by the regulations or requirements in this manual, there is danger of body injury even death and machine system damage. ● Only qualified personnel are allowed to operate the equipment.this product. Before using, the operator must be familiar with all safety specifications and operation regulations in this manual. Safe and stable work of the product is based on right operation and maintenance. ● Do not wire while the power is connected. Otherwise, there is danger of death for electric shock. Before wiring, inspection, maintenance, please cut power supply of all related equipments and ensure mains DC voltage in safe range. And please operate it after 5 mins.
	<ul style="list-style-type: none"> ● Away from children and public. ● Only used in application fields as maker stated. No use in equipments related to special fields such as emergency, succor, ship, medical treatment, aviation, nuclear and etc. ● Unauthorized alteration or use of accessories which are not sold or recommended by the maker may cause faults.
<p>Important</p>	<ul style="list-style-type: none"> ● Please make sure this manual is in the final user' hand before using. ● Before installation and debugging please carefully read and totally understand these safety regulation and warning signs.

● Transport and store regulation

	<ul style="list-style-type: none"> ● Correct transport, store, installation and careful operation an maintenance are important for inverter safe operation.
	<ul style="list-style-type: none"> ● In transport and store process, make sure the inverter is free from impact and vibration. It must be stored where is dry without corrosive air and conductive dust, and the temperature must be lower than 60°C.

● Installation and wiring regulation

	<ul style="list-style-type: none"> ● Only professional trained person can operate it. ● Power wire, motor wire and control wire should be all connected firmly. Earth must be reliable and earth resistance must be lower than 10Ω. ● Before opening the inverter, please disconnect all related equipment power supply and make sure the mains DC voltage is in safe range and operate after 5mins. ● Human body electrostatic will damage inner sensitive components seriously. Before operation, please follow ESD measures. Otherwise, there is danger of inverter damage. ● Inverter output voltage is pulse wave. If components such as capacitor which improves power factor and pressure-sensitive resistance for anti-thunder and so on are installed at the output side, please dismantle them or change to input side.
---	--

	<ul style="list-style-type: none"> ● No switch components such as breaker and contactor at the output side. (If there must be one, please make sure the output current is 0 while the switch acting).
	<ul style="list-style-type: none"> ● The power supply cable and motor cable specifications must satisfy all conditions in table 3-7 3-8 .

● Run regulation

	<ul style="list-style-type: none"> ● Inverter runs at high voltage. So dangerous voltage is in some components inevitably. ● No matter where the fault is, there is danger of serious accident, even human body injury what means dangerous malfunction possibility. So there must be additional external prevent measures or other safety devices, such as independent current limiting switch, machinery and so on.
---	---

● Maintenance regulation

	<ul style="list-style-type: none"> ● Only Shenzhen Veichi Electric co., ltd service department or its authorized service center or professional person trained and authorized by Veichi can maintain the products. They should be very familiar with the safety warning and operation gist in this manual. ● Any defective components must be changed in time. ● Before opening the inverter to repair please cut power supply of all related equipments and ensure mains DC voltage in safe range. And please do operation after 5 mins.
---	--

● Dismantlement and disposal regulation

	<ul style="list-style-type: none"> ● Packing case can be reused. Please keep them and reuse or send back to maker. ● Dismantled metal components are retractable and can be reused. ● Some components such as electrolytic capacitor are harmful to environment. Please dispose according to environmental protection departments.
---	---

1.2 Technical Specification

Tech. Specification	Items	Description
Power Input	Voltage, frequency	single phase 220V, 3 phase, 220V,380V, 660V and 1140V
	Allowable fluctuations	Voltage: $< \pm 15\%$; frequency $\pm 5\%$ Distortion of voltage to confirm to IEC61800-2
	Closing striking current	less than rated current
	Power Factor	≥ 0.94 (integrated DC reactor)
	Efficiency	$\geq 96\%$
Power Output	Output Voltage	3 Phase, 0~Input voltage, tolerance less than 5% in standard rating condition
	Frequency Control Range	G type: 0 to 400Hz, P type: 0-400Hz, Z type: 0-400Hz, L type: 0-400Hz, H type: 0-3000Hz.
	Output frequency accuracy	$\pm 5\%$ of maximum frequency
	Overload Tolerance	Z type: 150% rated current for 60 sec, 180% rated current for 30 sec, 250% rated current for instantaneous G, H, L type model: 150% of rated output current for 60 sec, 180% of rated current for 10s, 2 00% of rated current for instantaneous P type: 120% rated current 60 sec, 150% rated current for instantaneous
Key Control performance	Motor Control Mode	Open loop sensorless vector control without PG, V/F control
	Control system	Optimized Space Vector PWM Modulation
	Carrier frequency	0.6~15kHz, Randomly-modulated carrier
	Speed control range	OLV without PG with rated load: 1:100,
	Stable speed control accuracy	OLV without PG: less than 1% rated synchronous speed
	Torque response	OLV without PG control mode: ≤ 20 ms
	Frequency Accuracy (Temperature Fluctuation)	Digital inputs: maximum $\times \pm 0.01\%$ Analog inputs: maximum $\times \pm 0.2\%$
Standard Function	DC Braking	Starting Frequency: 0.00 to 50.00Hz, Braking Time: 0.0 to 60.0s Braking current: 0.0 to 150% rated current
	Torque boost	Auto torque boost: 0.0% to 100% Manual torque boost: 0.0% to 25%

V/F curve	5 kinds curve programmable setting:1 user setting, 1 of linear characteristic torque curve setting. 3 kinds derating torque setting(1.5 power, 1.7 power, 2.0 Power curve)
Accel / Decel. curve	Two kinds curve: line Accel/Decel, S curve Accel/Decel. 4 Accel/Decel time unit is 0.1s, maximum time 6500.0s
Rated output voltage	Power voltage compensation is available, setting range from 50 to 100%(rated voltage), the output voltage can't over than input
AVR(Auto Voltage Regulation	automatic voltage regulation for keeping output voltage stable when fluctuation of grid
Auto energy saving running	Optimized the output voltage according the load to achieve energy saving
Auto current limit	Auto current limit during running mode to avoid trip occurs frequently
Momentary Power Loss with no stop running function	To achieve continuous running with regenerative enery and DC bus voltage regulation when momentary power loss
Standard Function	PID control, Carrier frequency adjustable, current limiter, Speed Search, Momentary Power Loss restart,8 Step Speed (max), 3-wire Sequence, Slip Compensation, Frequency Jump, Upper/lower Limits for Frequency Reference, DC Injection Braking at Start and Stop, Energy Saving Control, Modbus Comm RS485, Fault Restart, job function, Cooling Fan on/off Switch, timing stop, high pulse output, programmable auto running, swing frequency, counter, frequency arriving detect and frequency lever detect.
Frequency Setting Methods	Keypad digital setting, potentiometer of keypad, analog voltage terminal VS1, analog voltage terminal VS2, analog current terminal AS, RS485 communication and multiple terminal, main and auxiliary composition setting.
Feedback Input Channel	voltage terminal VS1, VS2, current terminal AS, communication , and pulse input PUL
Running command channel	keypad given, external terminal given, communication given
Input command signal	Start, Stop, FEW/Reverse, Job, Multiple speed, free stop, Reset, Accel/Decel time, Frequency set point channel, External fault
Output signal	2 Photo coupler relays: 2 (24 V, up to 50 mA) 1 Contact relays: 1 (250 Vac/up to 1 A, 30 Vdc/up to 1 A) 0-10V output, 4 to 20mA output Frequency pulse output
Protection function	Overvoltage, under voltage, current limit, over current, overload, electric thermal relay, overheat, Stall prevention, parameter lock

keypad Display	LED Display	One line digit-segments LED display to monitor 1 running status Double line digit-segment display to monitor 1 running status
	Parameters copy	upload and download parameter code to achieve easy copy
	Monitor Function	Output frequency, Frequency set point, Out current, Output voltage, motor speed, PID feedback value, PID given setting, IGBT module temperature, I/O terminal status.
	Alarms	Overvoltage, under voltage, over current, short circuit, phase loss, over load, over heat, stall prevention, current limit, parameter lock damage, running status at present alarm, past trip alarm
Environment	Installation Site	Indoor, Altitude should less than 1000m, Free corrosive gases and direct sunlight
	Running Temperature, humidity	-10~+40°C (wall mounting), 20% to 95% RH (No condensation)
	Vibration	Less than 0.5g when frequency less than 20Hz
	Storage Temperature	-25—+65°C
	Installation mode	Wall-mounted mode, floor stand cabinet install
	Protection Degree	IP20
	Cooling Method	Forced air-cooling

Table 1: Technical Specification

Chapter 2 Before Use

2.1 Purchase Inspection

Pls check whether any package is damaged while receiving the product you ordered. If the package is ok, pls open it and check the inverter. If damage caused in transport, it is not duty of Veichi company. But please contact Veichi or the transport company immediately.

After checking the product, please also check if the model is the one you ordered. The model of the product is on the nameplate "MODEL" column. If the model is not in accordance with your need, please contact the agent or the sales departments in our company.

2.2 Nameplate

Nameplate position and content



Chart 2-1: AC70 series inverter nameplate

Model explanation

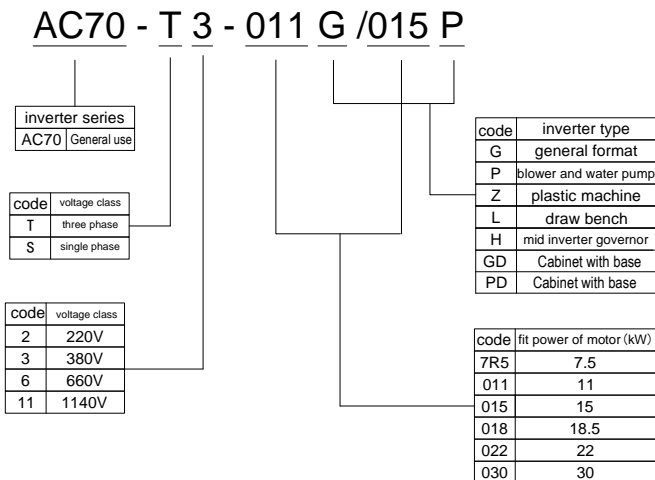

Chart 2-2: AC70series inverter nameplate meaning and naming rules

2.3 Rated Output Current



Input voltage	220V	380V	660V	1140V
Rated power (kw)	Rated output current (A)			
0.4	2.5			
0.75	4	2.3		
1.5	7	3.7		
2.2	10	5.0		
4	16	10		
5.5	20	13		
7.5	30	17	10	
11	42	25	15	
15	55	32	18	
18.5	70	38	22	
22	80	45	28	
30	110	60	35	
37	130	75	45	25
45	160	90	52	31
55	200	110	63	38
75	260	150	86	52
90	320	180	98	58
110	380	210	121	75
132	420	250	150	86
160	550	310	175	105
185	600	340	198	115
200	660	380	218	132
220	720	415	235	144
250		470	270	162
280		510	330	175
315		600	345	208
355		670	380	220
400		750	430	260
450		810	466	270
500		860	540	325
560		990	600	365
630		1100	680	400

Chapter 3: Installation and Wiring

3.1 Safety Precautions

This chapter explains the warnings for safe use and stable running of the product.

Cautions in use

	<ul style="list-style-type: none"> ● While install the inverter in the closed cabinet, please build in cooling fan, air-conditioner or other cooling equipment to ensure the temperature at the air-in port below 40°C. So that the inverter can work safely and reliably.
	<ul style="list-style-type: none"> ● While installing, please use cloth or paper cover the inverter to prevent metal dust, oil, water and others. And remove it carefully after working. ● While operation, please follow the ESD regulations. Otherwise, the inverter may be damaged. ● While multi inverters are installed in the same cabinet, enough space must be left for cooling fan. ● Inverter can not work over rated range. Otherwise, the inverter may be damaged. ● While transporting the inverter, please hold the firm case. If only hold the pre-cover, there is danger of inverter main body falling, injury or inverter damage.

Cautions in use motor

	<ul style="list-style-type: none"> ● Different motor has different max allowable running speed. Motor can not run over the max allowable running speed. ● While inverter is running at low speed, the motor auto-cool effect is seriously worse. If motor runs at low speed for long time, it will be damaged for overheat. If needed, please use special motor for inverter. ● While constant speed machinery runs at inconstant speed, there maybe sympathetic vibration. Please install vibration-proof rubber under motor rack or use jumping frequency control function. ● While using frequency inverter or working frequency power supply to drive, the torque characteristic are different. Please do confirm the torque characteristic of the equipment connected. ● The rated current of shift gear motor is different from that of standard motor. Please confirm it and choose the right frequency inverter. Moreover, please do switch the pole while the inverter input current is 0. Otherwise it may bring inverter protection or damage. ● The rated current of diving motor is higher than that of standard motor, please confirm it and choose the right inverter. ● While the wire between motor and inverter is long, the max torque of the motor will reduce for voltage drop. So please use thick cable while the distance between the motor and the inverter is long.
--	--

3.2 Treatment for Inverter after Longtime Store

If the inverter store time is over one year, you must pre-charge the aluminum capacitor in the inverter again and install the inverter after the aluminum capacitor characteristic recovering. For the specific method, please follow the grads in the chart below and give corresponding proportional voltage for every grad more than 30 mins while the inverter is no-load.

If the input voltage of one grad is at the action critical point of contactor, fan or other equipment, please increase or reduce the corresponding input voltage for the grad to avoid any component working under critical state.



Chart 3-1: treatment for inverter after longtime store

3.3 Inverter Stable Running Environment

Installation environment is very important to the best use of this product for long time. Pls install this product in the environment as the following table requirement.

Environment	Requirement
Install place	Indoor without direct sunshine
Install temperature	-10 ~ +40℃
Store temperature	-20 ~ +60℃
Humidity	<95%RH, no condensation
Surrounding	Please install the inverter in place as follows: <ul style="list-style-type: none"> ● Place without oil mist, corrosive gases, flammable gas, dust or etc. ● Place without metal dust, oil, water or etc into inverter (please do not install inverter on flammable material such as food and etc). ● Place without radioactive material or flammable material. ● Place without poisonous gases or liquid. ● Place with very little salification erosion. ● Place without direct sunshine.
Altitude	<1000m
Vibration	<10~20Hz:9.8m/s ² <20~55Hz:5.9m/s ²
Installation and cooling	<ul style="list-style-type: none"> ● Inverter can not be installed horizontally must be installed vertically. ● Please independently install high heating equipments such as braking resistor and etc which can not be installed in the same cabinet with inverter, installed at the air-in port of the inverter is strictly prohibited.

Table 3-1: AC70 series inverter running environment condition

- In order to improve the product stability, pls do not use the inverter where temperature changes sharply. While using in closed space such as control cabinet, please use cooling fan or air-condition to cool inverter to avoid temperature over limit range. Please also prevent inverter from freeze, too low temperature may cause components freeze fault.

- Derate according to the chart while over temperature limit.

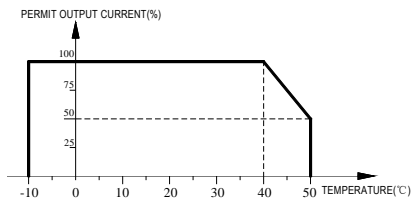

Chart 3-2: AC70 series inverter derating curve while over permit temperature

- Derate according to the chart while over altitude limit.

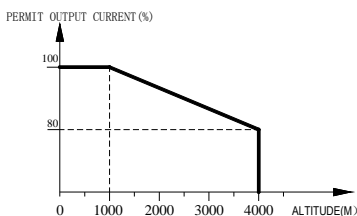



Chart 3-3: AC70 series inverter derating curve while over permit altitude

3.4 EMI Protection

The inverter is designed to be used in industrial environment with strong electromagnetic interference. Generally speaking, if the installation quality is good, it is ensured that the inverter can work safely without fault. Please install the inverter according to the following rules to ensure stable running and avoid electromagnetic interference impact.

- Ensure that all equipments in the cabinet have been connected reliably to the common Y-type earth point or earth bus with thick and short cable. The motor earth should be as close as possible. Please do not connect the motor case to the inverter earth terminal or the protective area of control system.
- Ensure that all equipments connected to the inverter have been reliably connected to the same earth net or Y-type earth point with thick and short cable.
- The conductor has better to be flat and with multi core, what has lower resistance at high frequency.
- The cutting terminal should be as soigne as possible. Unshielded wire section must be as short as possible.
- In control cable wiring, it should be as far from the power supply cable and motor cable as possible. And independent cable trough should be used. While the control cable must cross to the power supply cable or motor cable, it should be 90° vertical cross.
- Ensure that the contactor in the cabinet has wave surge suppresser. Or 'R-C' damping circuit is connected to the winding of AC contactor. Voltage dependent resistor corresponding to the winding voltage is used. And freewheel diode or components such as voltage dependent resistor corresponding to the winding voltage are connected to DC contactor. It is very important while contactor, controlled by output relay of inverter, acts frequently.
- Cable connected to motor should be shielded cable or armoured cable. The two barriers are earthed reliably by cable grounding card.
- Build noise filters at the input side to reduce electromagnetic interference from other equipments at the power grid side. The noise filter should be as close to the inverter power input terminal as possible. Meantime, the filter must earth reliably as the inverter.
- Build noise filters at the output side to reduce radio interference and inductive disturbance. The noise filter must be as close to the inverter output terminal as possible. Meantime, the filter must earth reliably as the inverter.

- Anytime, control circuit wire should be shielded cable.
- Add zero phase reactor in power supply wire near inverter input terminal and add zero phase reactor in the motor wire near inverter output terminal to reduce electromagnetic interference to the inverter efficiently.
- Earthing Right and reliable earthing is the basic condition of safe and reliable running of the product. For right earthing, please read the following notice carefully.

	<ul style="list-style-type: none"> ● In order to avoid electric shock, earthing cable should be the size as electric equipment technique standard required and cable length should be as short as possible. Otherwise, inverter leakage current will cause unstable potential of the earthing terminal which is far from the earthing point, and electric shock accident will happen frequently. ● Earth terminal must be earthing. Earth resistance must be below 10Ω. Otherwise, there is danger of death.
	<ul style="list-style-type: none"> ● Please do not share earth cable with welder or other big current/pulse power equipment. Otherwise, inverter will act abnormally. ● While multi inverters are used at the same time, please do not wind the earth wire to loop-type. Otherwise, inverter will act abnormally.

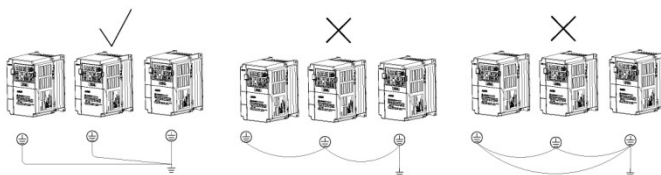

Chart 3-4: multi AC70 series inverters united earthing

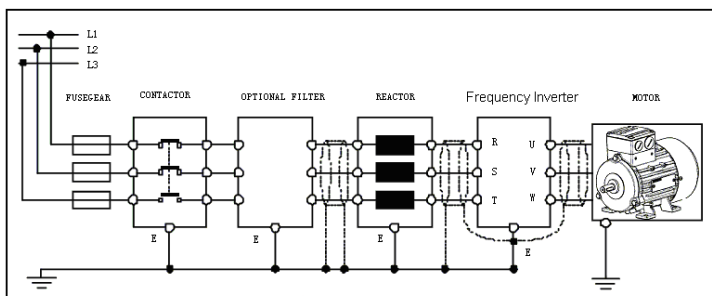

Chart 3-5: AC70 series inverter system earthing

Remark: motor must earth as close as possible. Motor case can not be connected to the inner earth terminal of the inverter. It also can not share the earth net with the control system.

- Shield of inverter power cable, motor cable, control cable

Shielding layer (reticulate/armoured) should be wound reliably by cable earth card and fix to inverter earth piece by bolt. Please refer to the following chart.

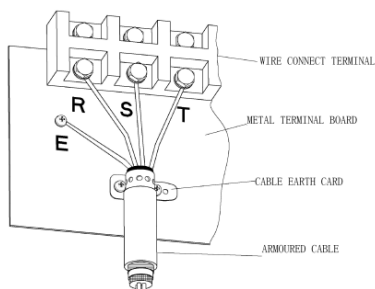

Chart 3-6: Cable earth card for cables earthing

- Corresponding relationship between inverter/motor cable length and carrier frequency.

While cable distance between inverter and motor is long (especially low frequency output), cable voltage drop will make motor torque reduce. Further more, cable HF leakage current will increase. Then inverter output current will increase, that will cause inverter over-current trip. The current detection accuracy and running stability will be impacted. Please follow as below table to adjust carrier frequency according to the cable length. While the cable distance is over 100m, please adopt distributed capacity reduce measure (Such as "no metal conductor covers cable", "wire each phase cable apart" and so on).

Cable length	<20m	20~50m	50~100m	>100m
Carrier frequency	0.7~15kHz	0.7~8kHz	0.7~4kHz	0.7~2kHz

Table 3-2: Corresponding relationship between inverter/motor cable length and carrier frequency

3.5 Machinery Installation

Installation notice and related requirement

- AC70 inverter components

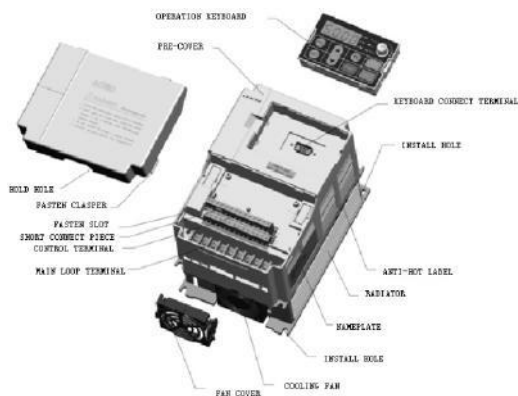

Chart 3-7: AC70 series inverter components

- Installation direction

To prevent inverter cooling effect reducing, please do install the inverter vertically.

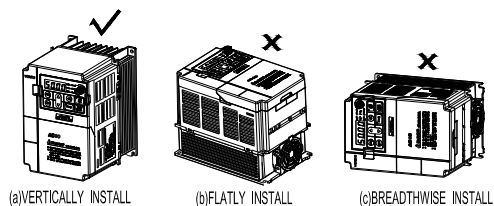

Chart 3-8: AC70 series inverter installation direction

- Installation space

Single machine installation: to ensure enough ventilation and wiring space for inverter cooling, please follow installation conditions as follows. The back of the inverter should stick to the wall. So that the surrounding air of radiator can flow freely to ensure the cooling effect.

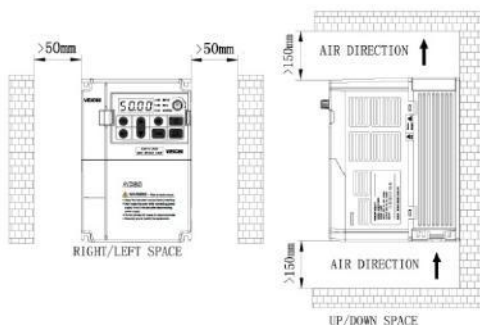

Chart 3-9: Single AC70 series inverter installation space

Multi inverters paratactic installation: while installing multi inverters in cabinet, please ensure installation space as follows.

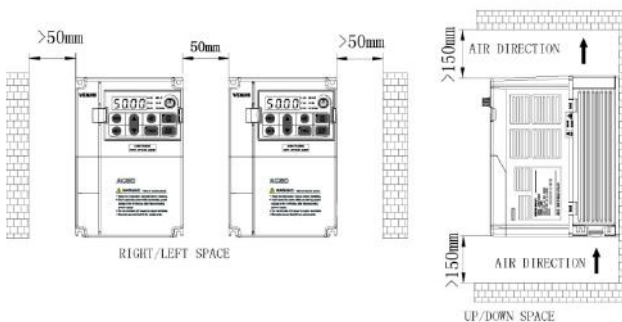
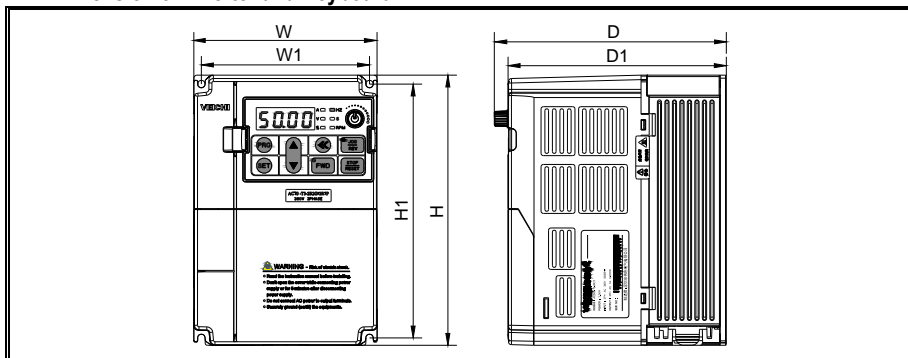
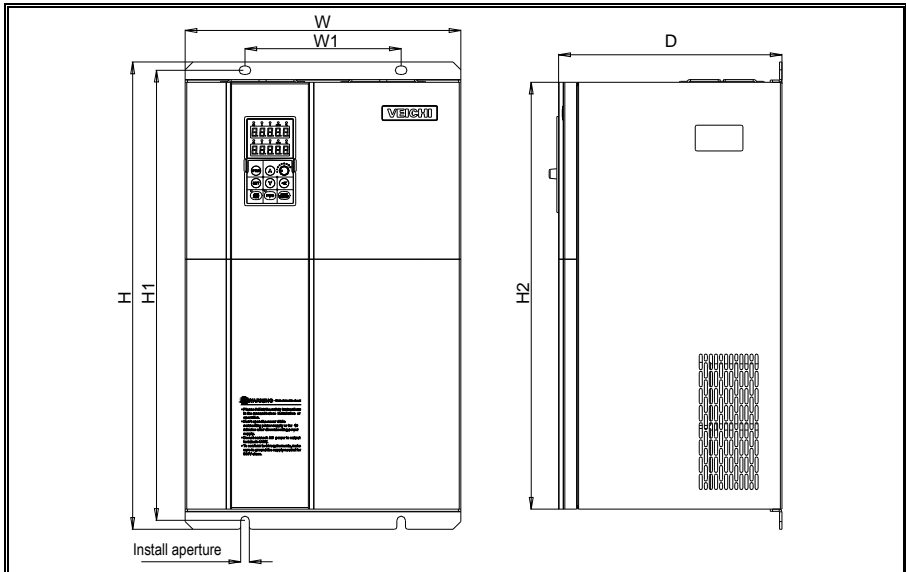

Chart 3-10: Multi AC70 series inverters paratactic installation space requirement

Dimension of Inverter and Keyboard



Inverter model	Inverter size				Install size		Install aperture
	W	H	D	D1	W1	H1	
AC70-S2-R40G	122	182	154.5	145	112	171	φ5
AC70-S2-R75G							
AC70-S2-1R5G							
AC70-S2-2R2G	159	246	157.5	148	147.2	236	φ5.5
AC70-S2-004G							
AC70-S2-5R5G	195	291	167.5	158	179	275	φ7
AC70-T3-R75G/1R5P	122	182	154.5	145	112	171	φ5
AC70-T3-1R5G/2R2P							
AC70-T3-2R2G/004P							
AC70-T3-004G/5R5P	159	246	157.5	148	147.2	236	φ5.5
AC70-T3-5R5G/7R5P							
AC70-T3-7R5G/011P	195	291	167.5	158	179	275	φ7
AC70-T3-011G/015P							
AC70-T3-015G/018P (plastic cover machine)	230	330	200	190	208	315	φ7
AC70-T3-018G/022P (plastic cover machine)							
AC70-T3-022G/030P (plastic cover machine)							



Inverter model	Inverter size			Install size		Install aperture	
	W	H	D	H2	W1		H1
AC70-T3-015G/018P (steel cover machine)	235	345	200	311	160	331.5	φ7
AC70-T3-018G/022P (steel cover machine)							
AC70-T3-022G/030P (steel cover machine)	255	410	225	370	180	395	φ7
AC70-T3-030G/037P							
AC70-T3-037G/045P	305	570	260	522	180	550	φ9
AC70-T3-045G/055P							
AC70-T3-055G/075P							
AC70-T3-075G/093P	380	620	290	564	240	595	φ11
AC70-T3-093G/110P							
AC70-T3-110G/132P							

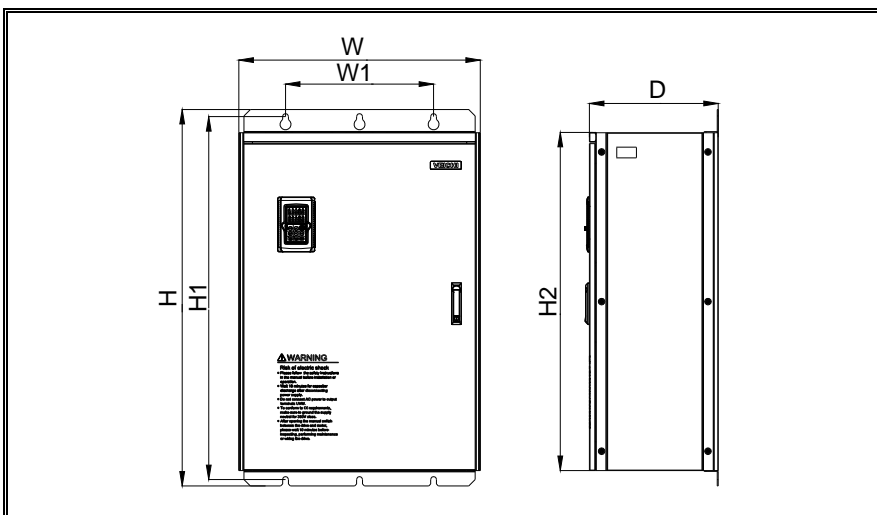

Inverter model	Inverter size			Install size		Install aperture	
	W	H	D	H2	W1		H1
AC70-T3-132G/160P	500	780	340	708	350	755	φ11
AC70-T3-160G/185P	650	1060	400	950	400	1023	φ16
AC70-T3-185G/200P							
AC70-T3-200G/220P							
AC70-T3-220G/250P	750	1170	400	1050	460	1128	φ18
AC70-T3-250G/280P							
AC70-T3-280G/315P							
AC70-T3-315G/355P	850	1280	450	1150	550	1236	φ20
AC70-T3-355G/400P							
AC70-T3-400G/450P							

NOTE: Without build-in dc reactor

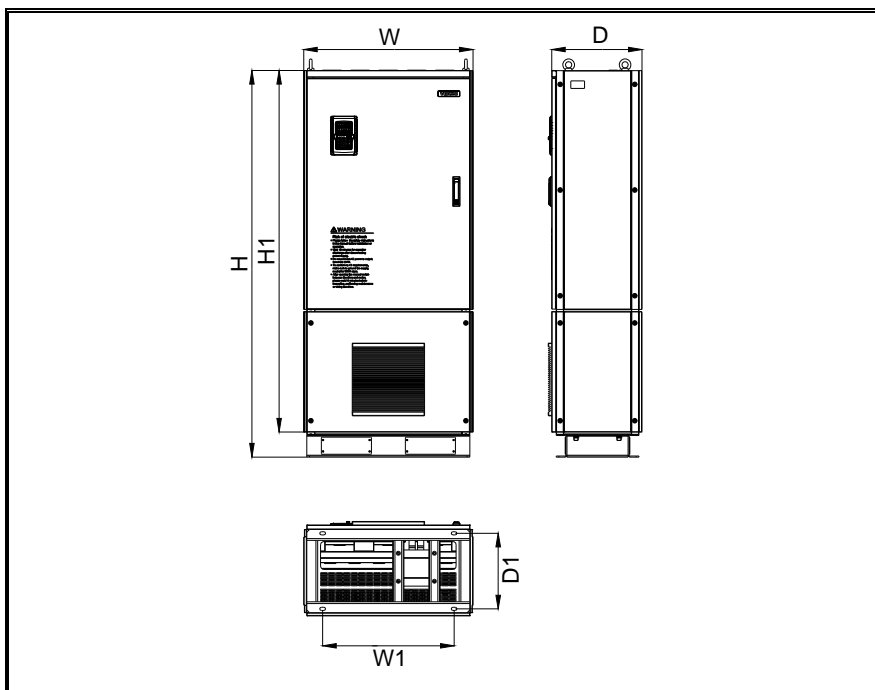

Inverter model	Inverter size				Install size		Install aperture
	W	H	D	H1	W1	D1	
AC70-T3-160GD/185PD	650	1600	400	1500	492	332	φ14
AC70-T3-185GD/200PD							
AC70-T3-200GD/220PD							
AC70-T3-220GD/250PD	750	1700	400	1600	582	332	φ14
AC70-T3-250GD/280PD							
AC70-T3-280GD/315PD							
AC70-T3-315GD/355PD	850	1800	450	1700	622	382	φ14
AC70-T3-355GD/400PD							
AC70-T3-400GD/450PD							

NOTE: With build-in dc reactor

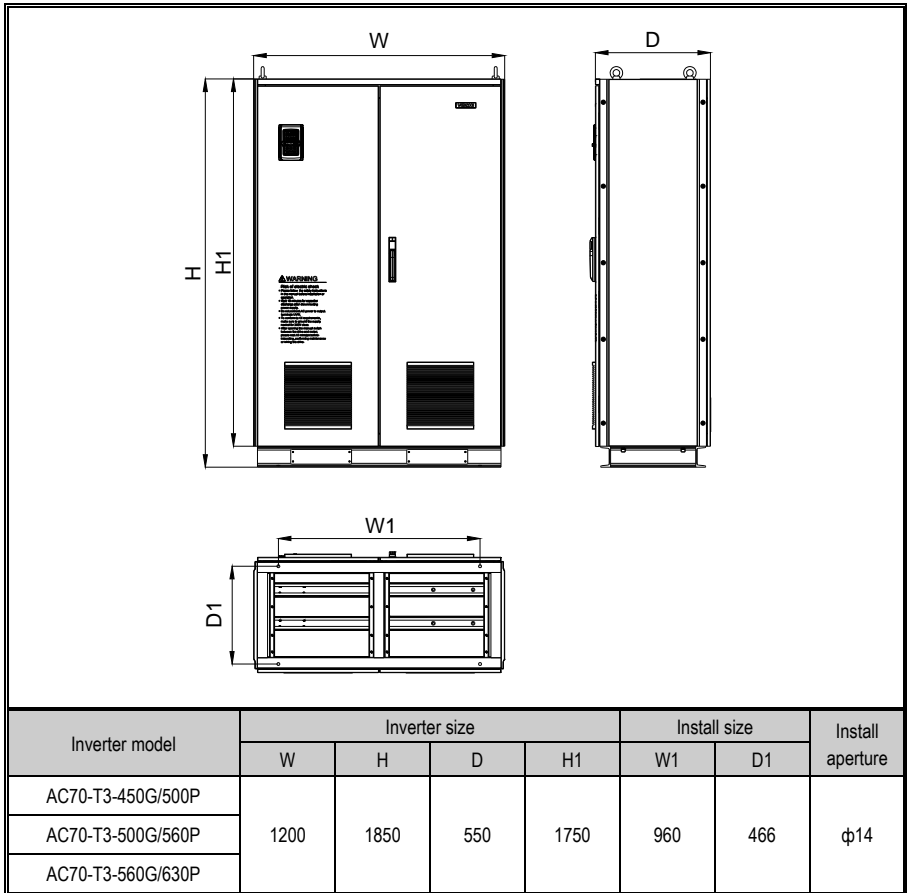

Table 3-3:AC70 series inverter dimension

Keyboard dimension

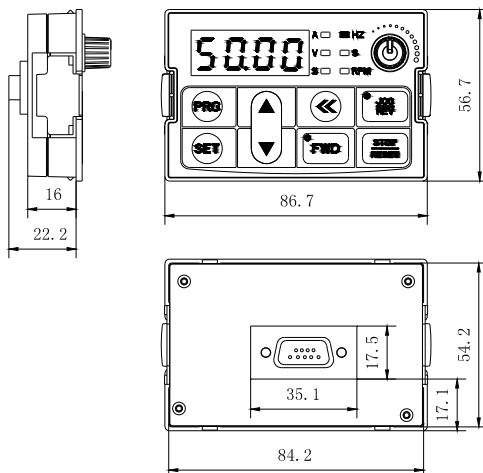

Chart 3-11:AC70 series inverter 1 line LED keyboard dimension

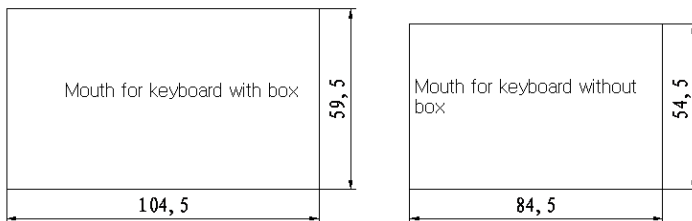

Chart 3-12:AC70 series inverter mouth for 1 line LED keyboard dimension

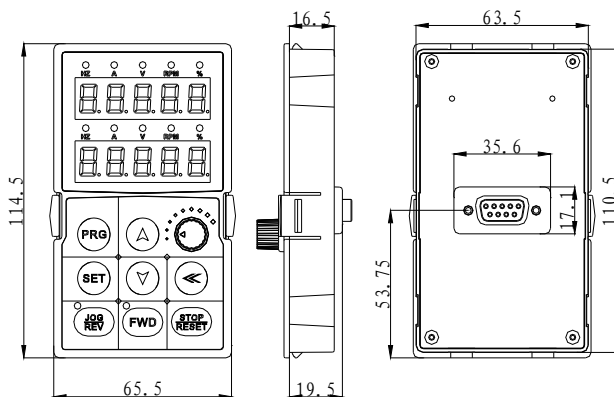

Chart 3-13:AC70 series inverter 2 line LED keyboard dimension

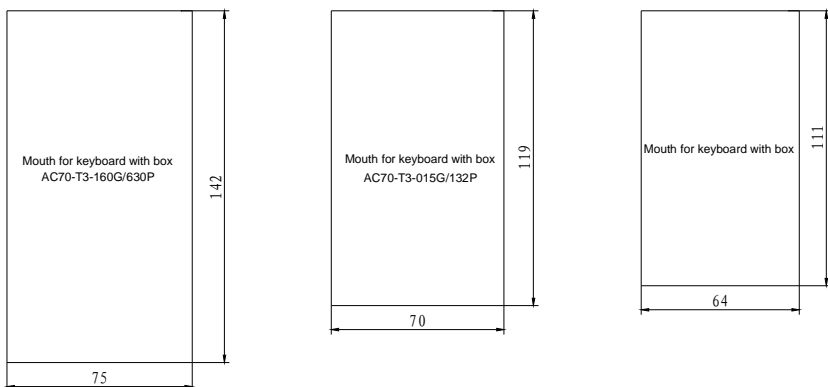

Chart 3-14:AC70 series inverter mouth for 2 line LED keyboard dimension

Note: LCD keyboard total same size as LED keyboard.

Dismantle and install tail-hood

Installation: First the tail-hood upwardly inclines around 15 degrees and inserts the top fixed flat into the fixed hole in the front cover. Then slightly press the tail-hood downward. While you hear "Ka", it means that the tail-hood is into the place.

Chart 3-15:AC70 series inverter tail-hood installation

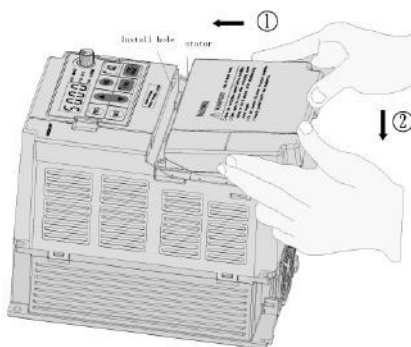

Dismantlement: At the tail of the frequency inverter, there is a special dismantlement hole design. Put your finger into the hole, upwardly pull the cover with a little force until the buckle between the tail-hood and the crust tear off, and then remove the tail-hood down.

Chart 3-16:AC70 series inverter tail-hood dismantlement

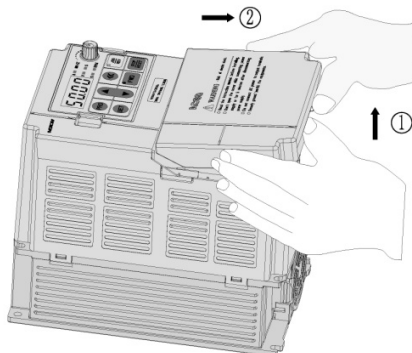

Dismantlement and installation of keyboard

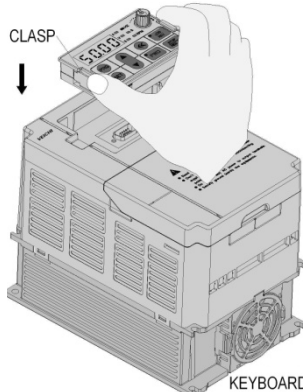

KEYBOARD INSTALLATION

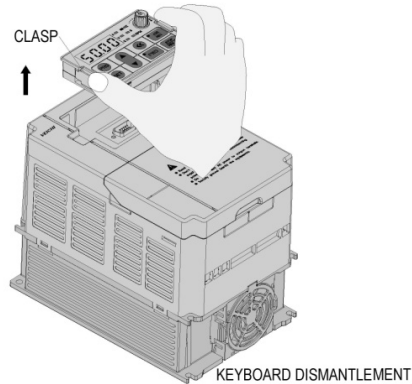



KEYBOARD DISMANTLEMENT

Chart 3-17: AC70 series inverter keyboard installation and dismantlement

3.6 Electric Installation

This chapter explains the regulations that users have to obey to ensure safe use, best performance and reliable running.

Safety precaution

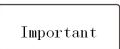
	<ul style="list-style-type: none"> ● Must earth reliably while inverter is running. Otherwise there is danger of casualty and unstable inverter performance. ● To ensure safe running, only trained professional person can do installation and wiring job. ● No operation under power connected state. Otherwise there is danger of electric shock even death. ● Before operation, please cut all related equipments power, ensure that the main circuit DC current has dropped to safe range. And please operate after 5 mins.
	<ul style="list-style-type: none"> ● Control cable, power cable and motor cable must be separated. They can not be in the same cable trough or cable rack. ● This equipment can only be used as the maker states. Please consult Veichi while using in special case.
	<ul style="list-style-type: none"> ● No insulation test for the inverter or the related cable by HV insulation test equipment. ● If the inverter or the peripheral equipment (filer, reactor and etc) needs insulation test, firstly 500V megohmmeter should be used to test the insulation resistance which should not be lower than 4MΩ.

Standard diagram

● Standard diagram

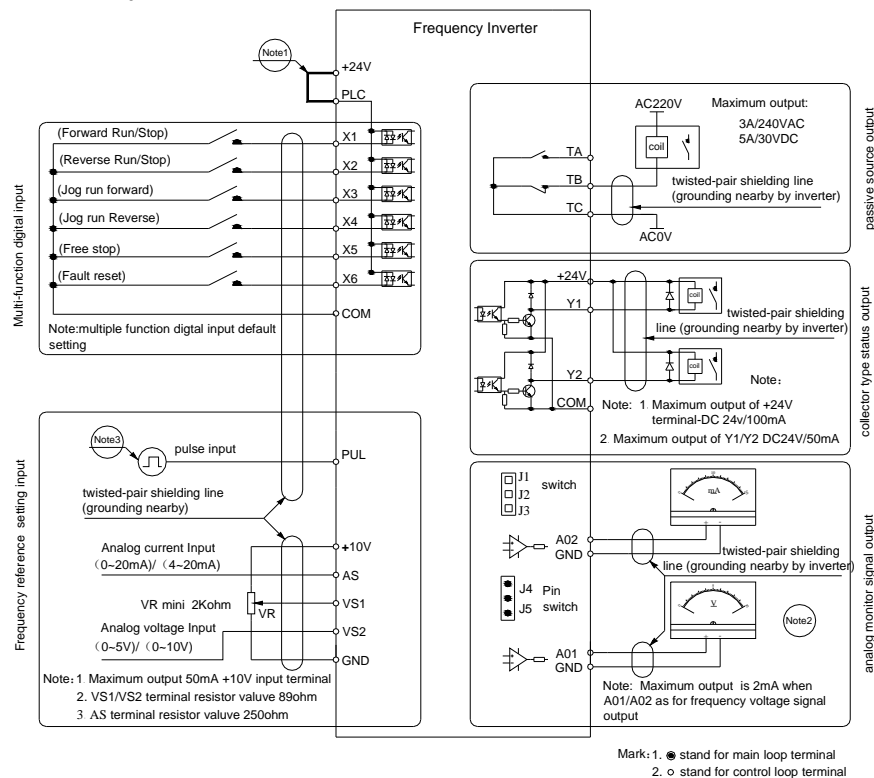

Chart 3-18:AC70 series inverter standard diagram

- Note: 1.NPN or PNP transistor signal can be selected as input of multi-function input terminal (X1~X6) . Inverter built-in power supply (+24V terminal) or external power supply (PLC terminal) can be chosen as bias voltage. Factory setting '+24V' short connect with 'PLC'.
2. Analog monitor output is special output of meters such as frequency meter, current meter, voltage meter and etc. It can not be used for control operations such as feedback control.
3. As there are multi pulse styles, please refer to the line connect mode description details.

● Auxiliary terminal output capacity

Terminal	Function definition	Max output
+10V	10V auxiliary power supply output, constitutes loop with GND.	50mA
A01/A02	Analog monitor output, constitutes loop with GND.	As frequency,voltage signal, max output 2mA
+24V	24V auxiliary power supply output, constitutes loop with COM.	100mA

Y1/Y2	Collector open circuit output, can set the action-object by program.	DC24V/50mA
TA/TB/TC	Passive connector output, can set the action-object by program.	3A/240VAC 5A/30VDC

Table 3-4:AC70 series inverter auxiliary terminals output capacity

● Switch terminals connection function specification











Switch terminal	Optional position	Picture example	Function specification
 (K2)	J1		(AO2) 0.0~50kHz open collect pole pulse frequency output
	J2		(AO2) 0~20mA current output or 4~20mA current output
	J3		(AO2) 0~10V voltage output
 (K1)	J4	 → J4 connect	(AO1) 0~10V voltage output
	J5	 → J5 connect	(AO1) 0~20mA current output or 4~20mA current output
 (K3)	J6	 → J6 connect	RS485 communication initial port connect matching resistor 120 Ω
	J7	 → J7 connect	Matching resistor disconnect

Table 3-5:AC70 series inverter switch terminal connection function specification

Main circuit wiring

● Main circuit wiring

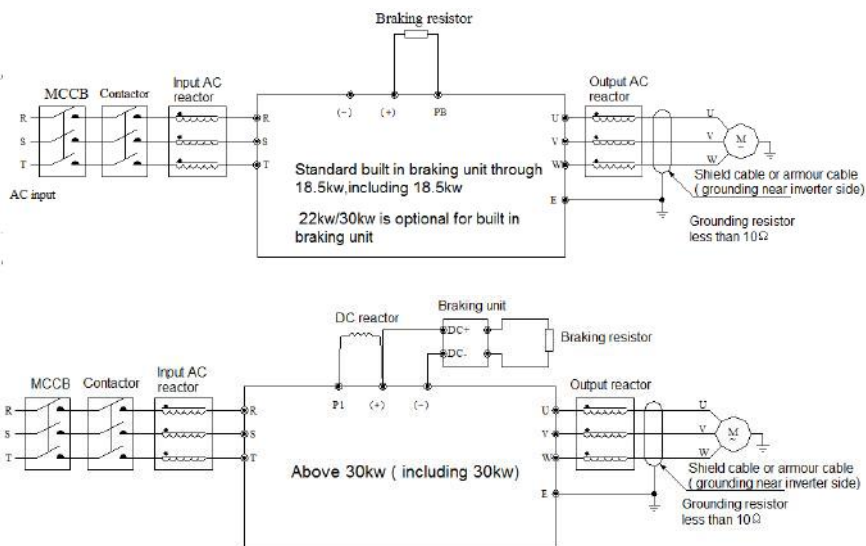

Chart 3-19: AC70 frequency inverter main circuit wiring

Note: 1, Fuse, dc reactor, braking unit, braking resistor, input actor, input filter, output reactor, output filter are optional parts, please refer to "peripheral equipment".

2, P1 terminal and (+) short connect. If need add dc reactor, please take away the short connect part between P1 and (+).

Main circuit terminals

● Main circuit terminals array and definition

Arrangement sequence of main circuit terminal with 18.5kW or less power (15 ~ 18.5KW for steel cover machine)

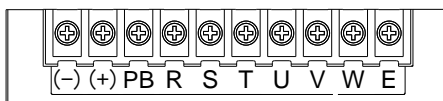

Arrangement sequence of main circuit terminal with 15-22KW (15-22KW for plastic cover machine)

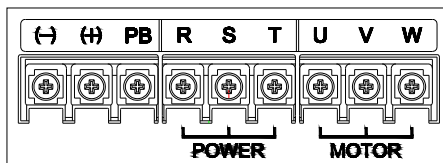

Arrangement sequence of main circuit terminal with 22~30KW (standard machine without PB terminal) (22KW for steel cover machine)

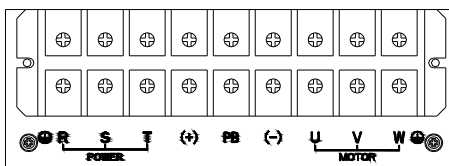

Arrangement sequence of main circuit terminal with 37~110kW

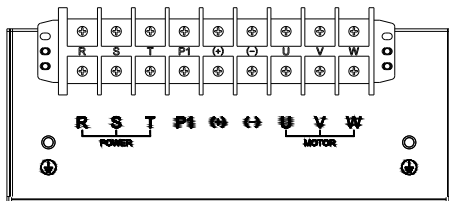

Arrangement sequence of main circuit terminal with 132kW:

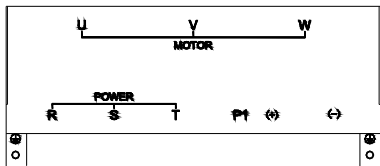

Arrangement sequence of main circuit terminal with 160~560kW

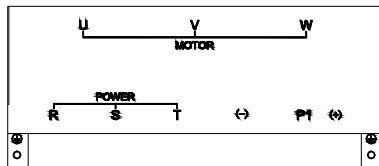

Terminal	Name	
(-)	DC power terminal	DC power output, (-) means DC bus cathode, (+) means DC bus anode, used for external braking unit.
(+)		
(+)	Braking resistance terminal	Used for external braking resistance to realize quick stop.
PB		
P1	DC reactor terminal	Used for external DC reactor.
(+)		
R	Inverter input terminal	Used to connect 3-phase AC power supply.
S		
T		
U	Inverter output terminal	Used to connect the motor.
V		
W		
⊕	Earth	Earth terminal, earth resistance<10 OHM
E		

Table 3-6:AC70 series inverter main circuit terminals array and definition

● 3-phase 380V machine main circuit wiring

Model	Main circuit terminals screw specifications	Suggested fixed moment (N·m)	Suggested Copper-core cable specification mm ² (AWG)
AC70-T3-R75G/1R5P	M4	1.2~1.5	1.5mm ² (14)
AC70-T3-1R5G/2R2P	M4	1.2~1.5	2.5mm ² (12)
AC70-T3-2R2G/004P	M4	1.2~1.5	2.5mm ² (12)
AC70-T3-004G/5R5P	M4	1.2~1.5	4mm ² (10)
AC70-T3-5R5G/7R5P	M4	1.2~1.5	6mm ² (9)
AC70-T3-7R5G/011P	M5	2~2.5	6mm ² (9)
AC70-T3-011G/015P	M5	2~2.5	10mm ² (7)
AC70-T3-015G/018P	M6	4~6	10mm ² (7)
AC70-T3-018G/022P	M6	4~6	16mm ² (5)
AC70-T3-022G/030P	M8	8~10	16mm ² (5)
AC70-T3-030G/037P	M8	8~10	25mm ² (3)
AC70-T3-037G/045P	M8	8~10	25mm ² (3)
AC70-T3-045G/055P	M8	8~10	35mm ² (2)
AC70-T3-055G/075P	M10	11~13	35mm ² (2)
AC70-T3-075G/093P	M10	11~13	50mm ² (1)
AC70-T3-093G/110P	M10	11~13	50mm ² (1/0)
AC70-T3-110G/132P	M10	11~13	70mm ² (2/0)
AC70-T3-132G/160P	M10	11~13	95mm ² (3/0)
AC70-T3-160G/185P	M12	14~16	95mm ² (4/0)
AC70-T3-185G/200P	M12	14~16	120mm ²
AC70-T3-200G/220P	M12	14~16	150mm ²
AC70-T3-220G/250P	M12	14~16	150mm ²
AC70-T3-250G/280P	M12	14~16	185mm ²
AC70-T3-280G/315P	M12	14~16	185mm ²
AC70-T3-315G/355P	M16	20~23	240mm ²
AC70-T3-355G/400P	M16	20~23	240mm ²
AC70-T3-400G/450P	M16	20~23	300mm ²
AC70-T3-450G/500P	M16	20~23	400mm ²
AC70-T3-500G/560P	M16	20~23	400mm ²
AC70-T3-560G/630P	M16	20~23	500mm ²

Note: Here we suggest to use copper joins as mains electric connectors of machine over 185KW. Pls refer the cut section area above.

Table 3-7: Suggested cable diameter and fixed moment 3-phase 380V machine main circuit

● Single-phase 220V machine main circuit wiring

Model	Main circuit terminals screw specifications	Suggested fixed moment (N·m)	Suggested Copper-core cable specification mm ² (AWG)
AC70-S2-R40G	M4	1.2~1.5	1.5mm ² (14)
AC70-S2-R75G	M4	1.2~1.5	2.5mm ² (12)
AC70-S2-1R5G	M4	1.2~1.5	2.5mm ² (12)
AC70-S2-2R2G	M4	1.2~1.5	4mm ² (10)

Table 3-8: Suggested cable diameter and fixed moment single-phase 220V machine main circuit

● Suggested main circuit components specification

Model	Contactur specification	Breaker specification	DC reactor	Input filter	Output filter
AC70-T3-R75G/1R5P	10A	10A	-----	NFI-005	NFO-010
AC70-T3-1R5G/2R2P	10A	10A	-----	NFI-005	NFO-010
AC70-T3-2R2G/004P	16A	15A	-----	NFI-010	NFO-010
AC70-T3-004G/5R5P	16A	20A	-----	NFI-010	NFO-010
AC70-T3-5R5G/7R5P	25A	20A	-----	NFI-020	NFO-020
AC70-T3-7R5G/011P	25A	30A	-----	NFI-020	NFO-020
AC70-T3-011G/015P	32A	40A	-----	NFI-036	NFO-036
AC70-T3-015G/018P	40A	50A	-----	NFI-036	NFO-036
AC70-T3-018G/022P	50A	60A	-----	NFI-050	NFO-050
AC70-T3-022G/030P	50A	75A	DCL-50	NFI-050	NFO-050
AC70-T3-030G/037P	63A	100A	DCL-80	NFI-080	NFO-080
AC70-T3-037G/045P	80A	125A	DCL-100	NFI-100	NFO-100
AC70-T3-045G/055P	100A	150A	DCL-110	NFI-100	NFO-100
AC70-T3-055G/075P	125A	175A	DCL-125	NFI-150	NFO-150
AC70-T3-075G/093P	160A	200A	DCL-150	NFI-150	NFO-150
AC70-T3-093G/110P	220A	250A	DCL-200	NFI-200	NFO-300
AC70-T3-110G/132P	220A	300A	DCL-200	NFI-200	NFO-300
AC70-T3-132G/160P	250A	400A	DCL-300	NFI-300	NFO-300
AC70-T3-160G/185P	300A	500A	DCL-300	NFI-300	NFO-300
AC70-T3-185G/200P	400A	600A	DCL-400	NFI-400	NFO-400
AC70-T3-200G/220P	400A	700A	DCL-400	NFI-400	NFO-400
AC70-T3-220G/250P	630A	800A	DCL-500	NFI-600	NFO-600
AC70-T3-250G/280P	630A	1000A	DCL-600	NFI-600	NFO-600
AC70-T3-280G/315P	630A	1200A	DCL-600	NFI-600	NFO-600
AC70-T3-315G/355P	630A	1200A	DCL-800	-----	-----
AC70-T3-355G/400P	800A	1400A	DCL-800	-----	-----
AC70-T3-400G/450P	1000A	1600A	DCL-1000	-----	-----
AC70-T3-450G/500P	1000A	2000A	DCL-1000	-----	-----

AC70-T3-500G/560P	1000A	2000A	DCL-1200	-----	-----
AC70-T3-560G/630P	-----	2000A	DCL-1200	-----	-----

Note: For DC reactor, input filter, output filter and other components specification details and circuit mode, please refer chapter 7 "peripheral equipments and options"

Table 3-9: Suggested mains fittings for 3-phase 380V machine

Control loop terminals

- Control loop terminals array

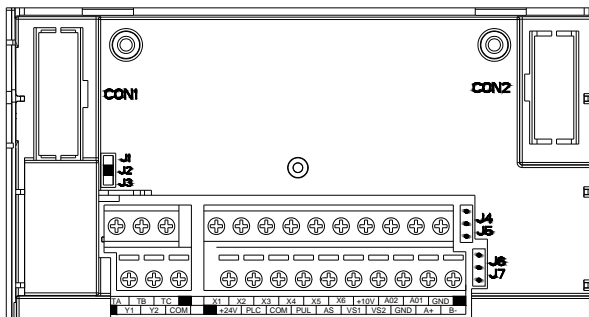

Sort	Terminal	Name	Function definition
Passive connection output	TA	Normally-open contact	Can set the action-object by programme. Max contact capacity:3A/240VAC 5A/30VDC
	TB	Normally-closed contact	
	TC	Common contact	
State output	Y1	Collector open output 1	Can set the action-object by programme. Max contact capacity:DC30V/50mA
	Y2	Collector open output 2	
Auxiliary power supply	+24V	Auxiliary power output +	Max output: 24VDC/100mA.
	COM	Auxiliary power output -	
Multi-function contact input	X1	Multi-function contact input 1	Build-in photoelectric converter can set the action-object by program. Input condition: Max DC30V/8mA. Note:Factory setting is common-collector characteristic input. If need common-emitter characteristic input, please remove the short connector between"+24V" and "PLC"; then use the short connector to connect "PLC" and "COM".
	X2	Multi-function contact input 2	
	X3	Multi-function contact input 3	
	X4	Multi-function contact input 4	
	X5	Multi-function contact input 5	
	X6	Multi-function contact input 6	
	PLC	Multi-function contact input common terminal	
Pulse input	PUL	Pulse input	Pulse range:0.0~50.00kHz. Factory setting is collector open output (R80,R82 transfer to R81,R83 can be active input)

Analog output	A01	Analog output 1	Can set the action and object by program. Physical type of output signal: 0~10VDC. 0~20mA, 4~20mA. It can be selected by parameter [F-62] and J4,J5 (see table 3-5)
	A02	Analog output 2	Can set the action-object by program. Physical type of output signal: 0~10VDC. 0~20mA, 4~20mA, It can be selected by parameter [F-62] and J1 J2 J3 (see table 3-5)
Analog input	AS	Current analog input	As inverter control signal or feedback signal, can set the act range and response speed by program. VS1/VS2 resistance:100KΩ; AS resistance: 250Ω.
	VS1	Voltage analog input 1	
	VS2	Voltage analog input 2	
Signal auxiliary power supply	+10V	Signal auxiliary power supply terminal	Max output 10VDC/50mA
	GND	Signal auxiliary power supply terminal	Common auxiliary power of analog output, analog input signal.
Communication terminal	A+	Communication terminal A+	RS485 communication port
	B-	Communication terminal B-	

Table 3-10:AC70 series inverter control loop terminals array and definition

- Control loop terminal wiring specification

Terminal	Bolt specification (mm)	Fixed moment (N·m)	Cable specification (mm ²)	Cable type
A+ B-	M2.5	0.4~0.6	0.75	Twisted-pair shielded cable
+10V GND A01 A02 VS1 VS2 AS	M2.5	0.4~0.6	0.75	Twisted-pair shielded cable
+24V COM Y1 Y2 TA TB TC PLC PUL X1 X2 X3 X4 X5 X6	M2.5	0.4~0.6	0.75	Shielded cable

Table 3-11:Control loop terminal wiring specification

Braking unit (braking resistance) connection

- Brake resistance wiring of machine with 18.5KW or less power (15KW-18.5KW for steel cover machine)

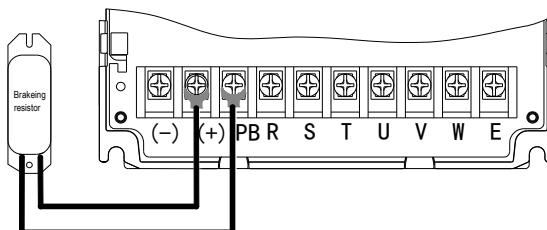

Fig 3-20: AC70 Series Frequency Inverter Brake resistance wiring of machine with 18.5KW or less power

- Brake resistance wiring of machine with 15-22KW (for plastic cover machine)

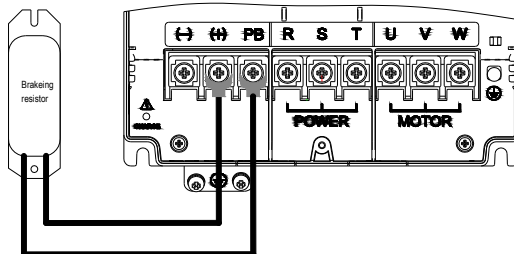

Fig 3-21: AC70 Series Frequency Inverter Brake resistance wiring of machine with 15-22KW (for plastic cover machine)

- Brake resistance wiring of machine with 22KW and 30KW(built-in brake is optional) (22KW for steel cover machine)

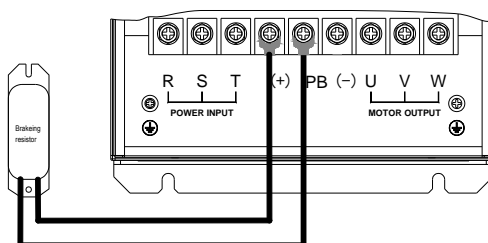

Fig 3-22: AC70 Series Frequency Inverter Brake resistance wiring of machine with 22KW and 30KW(built-in brake is optional) (22KW for steel cover machine)

- Brake resistance wiring of machine with 37KW or above

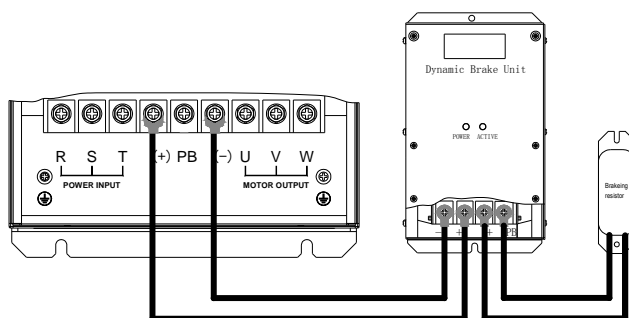

Fig 3-23: AC70 Series Frequency Inverter Brake resistance wiring of machine with 37KW or above

- Suggested braking resistance specification parameters

Braking resistance value and power in the chart are decided according to common inertia load and intermittent braking mode. While used in large inertia occasion or long time frequent brake occasion, please adjust resistance value and power according to the inverter specification and the rated parameter of braking unit. If any problem, please consult customer service department of Veichi Electric Com., Ltd.

Three-phase 380V			
Motor power(kW)	Resistance value(Ω)	Resistance power(W)	Braking torque (%)
0.75 kW	750 Ω	150W	100%
1.5 kW	400 Ω	300W	100%
2.2 kW	250 Ω	400W	100%
4.0 kW	150 Ω	500W	100%
5.5 Kw	100 Ω	600W	100%
7.5 kW	75 Ω	780W	100%
11 kW	50 Ω	1,200W	100%
15 kW	40 Ω	1,500W	100%
18.5 kW	32 Ω	2,000W	100%
22 kW	28 Ω	2,200W	100%
30 kW	24 Ω	3,000W	100%
37 kW	20 Ω	3,700W	100%
45 kW	16 Ω	4,500W	100%
55 kW	13 Ω	5,500W	100%
75 kW	9 Ω	7,500W	100%
90 kW	6.8 Ω	9,300W	100%
110 kW	6.2 Ω	11,000W	100%
132 kW	4.7 Ω	13,000W	100%
160 kW	3.9 Ω	15,000W	100%
185 kW	3.3 Ω	17,000W	100%
200 kW	3 Ω	18,500W	100%
220 kW	2.7 Ω	20,000W	100%
250 kW	2.4 Ω	22,500W	100%
280 kW	2 Ω	25,500W	100%
315 kW	1.8 Ω	30,000W	100%
355 kW	1.5 Ω	33,000W	100%
400 kW	1.2 Ω	42,000W	100%
450 kW	1.2 Ω	42,000W	100%
500 kW	1 Ω	42,000W	100%
560 kW	1 Ω	50,000W	100%
Single-phase 220V			
Motor power(kW)	Resistance value(Ω)	Resistance power(W)	Braking moment (%)
0.4 kW	400 Ω	100W	100%
0.75 kW	200 Ω	120W	100%
1.5 kW	100 Ω	300W	100%
2.2 kW	75 Ω	300W	100%

Table 3-12: Suggested braking resistance specification parameters of AC70 series inverter

- Build-in braking unit max braking performance

Braking unit of AC70 series product with low power can be selected according to the suggested braking resistance specification parameters in table 3-11. In large inertia or long time frequent brake occasion, the moment maybe should be increased. The max braking power is showed in the following table, the range of which can not be over in use. Otherwise the equipment maybe destroyed. If any problem, please consult Veichi Electric Com., Ltd customer service department.

Three-phase 380V			
Inverter model	Motor power	Max braking current	Min resistance
AC70-T3-R75G/1R5P	0.75 kW	3.5A	200Ω
AC70-T3-1R5G/2R2P	1.5 kW	3.5A	200Ω
AC70-T3-2R2G/004P	2.2 kW	7A	100Ω
AC70-T3-004G/5R5P	4 kW	10A	75Ω
AC70-T3-5R5G/7R5P	5.5 kW	10A	75Ω
AC70-T3-7R5G/011P	7.5 kW	14A	50Ω
AC70-T3-011G/015P	11 kW	17A	40Ω
AC70-T3-015G/018P	15 kW	23A	30Ω
AC70-T3-018G/022P	18.5 kW	28A	25Ω
AC70-T3-022G/030P	22 kW	30A (optional)	24Ω(optional)
AC70-T3-030G/037P	30 kW	35A (optional)	22Ω(optional)
Single-phase 220V			
Inverter model	Motor power	Max braking current	Min resistance
AC70-S2-R40G	0.4 kW	3.8A	100Ω
AC70-S2-R75G	0.75 kW	3.8A	100Ω
AC70-S2-1R5G	1.5 kW	6.5A	60Ω
AC70-S2-2R2G	2.2 kW	10.5A	40Ω

Table 3-13: AC70 series inverter build-in braking unit max braking power

Multi-function contact input connection

- NPN transistor connection mode

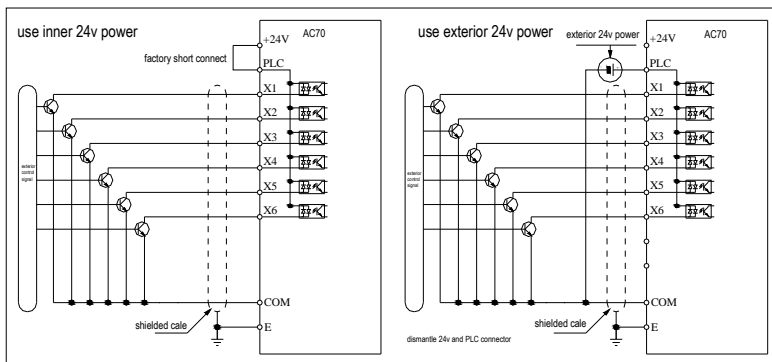

Chart 3-24: NPN transistor digital input signal connection mode

- PNP transistor connection mode

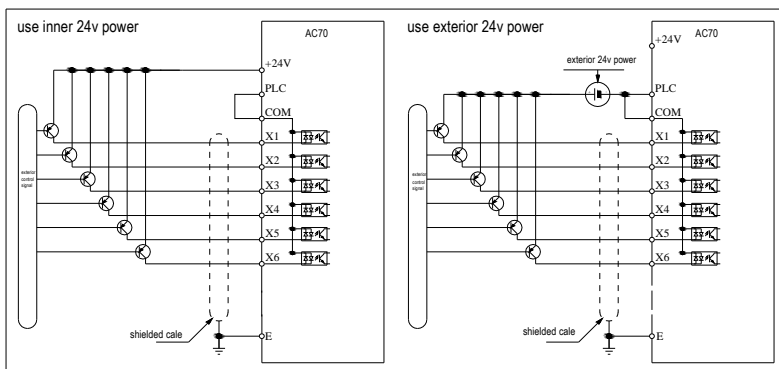

Chart 3-25 PNP transistor digital input signal connection mode

Digital output signal connection

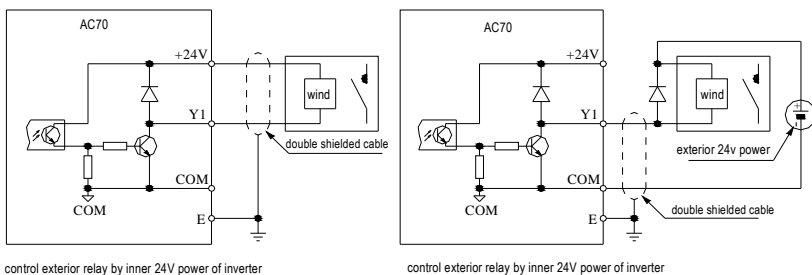

Chart 3-26: AC70 series inverter digital output signal connection mode

Analog output signal connection

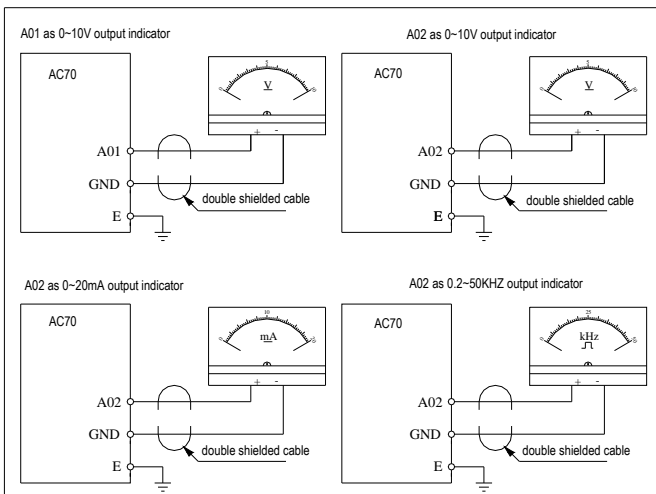

Chart 3-27:AC70 series inverter analog output signal connection mode

Connection of pulse input signal

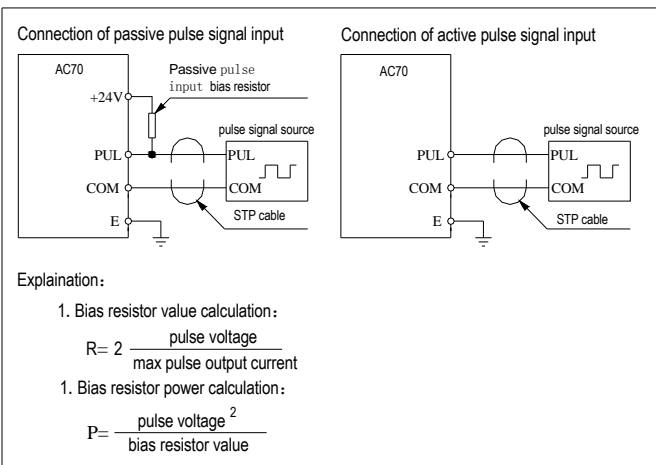

Chart 3-28: Pulse input signal connection mode of AC70 series inverter

Standby control system

Frequency inverter is composed of semiconductor, passive electronic component and driving part. All of them have useful time, which means these parts may happen characteristic change or out of use in normal working environment. And it will cause product fault. To avoid production stop led by the fault, we suggest preparing standby control system when using the inverter.

Chart 3-29 is a standby control system for manual switch to power supply driving motor at inverter fault. Standby control systems such as power supply Y/Δ step-down start way driving motor, power supply self-coupling reduction voltage start mode driving motor, power supply soft start mode driving motor or standby inverter system can be chose to use according the actual requirement and environment.

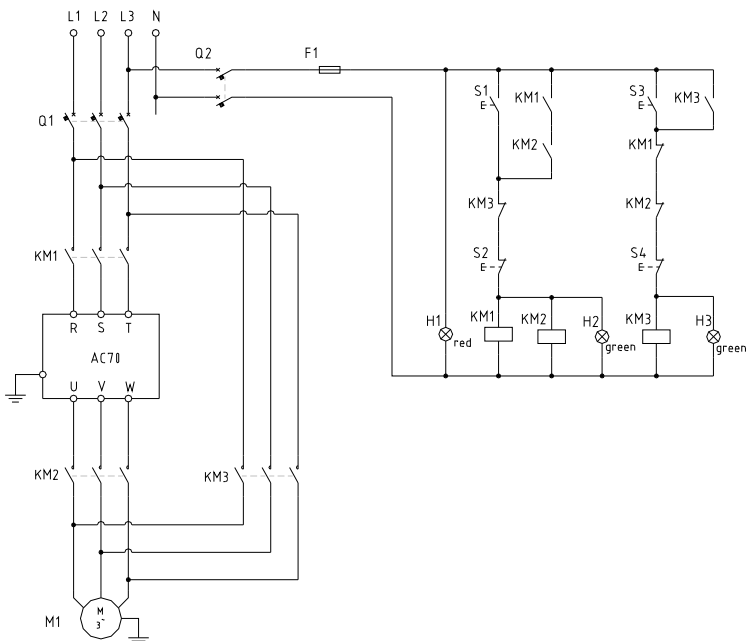





Chart 3-29: Standby control system of power supply directly driving mode

Chapter 4: Basic Operation and Trial Run

4.1 Safety Precautions

 <p>Danger</p>	<ul style="list-style-type: none"> ● No wiring while power supply is connected. Otherwise there is danger of electric shock.
 <p>Warn</p>	<ul style="list-style-type: none"> ● No operation while the cover is open. Otherwise, there is danger of electric shock. ● Please ensure reliable earth. Otherwise, there is danger of electric shock and fire. ● Before wiring please cut power supply of all related equipments and ensure main DC voltage in safe range. And please do operation after 5 mins. ● Only professional trained person is allowed to operate this product. ● Please do not dismantle the inverter cover while it is electrified. Otherwise, there is danger of electric shock. ● Please do not touch the printed circuit board of the inverter while it is electrified. Otherwise, there is danger of electric shock. ● Please ensure reliable mains cable connection. If the mains cable is loose, there is danger of fire caused by joint overheat. ● Before electrifying, please check the power voltage again. Wrong power voltage can cause fault or damage the inverter, even cause fire. ● Please do not install inverter on flammable material or attach flammable material to the inverter. Before electrifying, please clear the surroundings.
 <p>Important</p>	<ul style="list-style-type: none"> ● While operation, please follow the ESD regulations. Otherwise, the inverter maybe damaged. ● Please don't cut the power directly while the inverter drives the motor running. The power can't be cut until the motor totally stop. Otherwise, the inverter maybe damaged. ● Please don't cut or connect motor while the inverter drives the motor running. The motor can't be cut or connect until the inverter output is 0. Otherwise, the inverter maybe damaged. ● Control cable should be twisted-pair shielded cable. The barrier should be connected to the inverter earth terminal reliably to prevent the inverter from abnormal working. ● Unprofessional person can not operate, install, wiring, debug and maintain. ● Change, dismantle or maintain without permission may cause inverter damage. This case is not within our quality assurance range.

4.2 Keyboard Layout and Functions Specification

● Keyboard appearance



● Key function

Key	Name	Function
	Menu key	Enter menu while standby or running. Press this key to return while modify parameter. While standby or running, press for 1 sec to enter condition monitoring interface.
	Confirm/modify key	Press to modify parameter while in menu interface. Press again to confirm after modifying. While standby or running, press to change LED monitoring items at stop.
	Up/down key	Select parameter group in menu interface. Modify parameter while in modify interface. Modify given frequency, PID, given torque or magnetic powder clutch given torque while at standby or condition monitoring state.
	Shift key	Select digit of function no modified by up/down key: Select parameter digits modified by up/down key. Change LED monitoring items while standby or running.
	Forward run key	While run/stop is controlled by keyboard, press this key, the inverter forward rotate and the indicator is always on. While reverse, the indicator sparks.
	Jog/reverse key	This key function can be defined by parameter [E-08]. Press it, machine reverses and indicator is off if this key is defined as REVERSE. Machine will jog and indicator is on if this key is defined as JOG.
	Stop/reset key	Machine stops if press it while run/stop is controlled by keyboard. Its efficiency range is defined via function no [F-07]. Inverter resets if press it in fault state (no reset if fault is not solved).
	Keyboard potentiometer	Can be used as input channel for given frequency, upper frequency limit, given torque, given PID or PID feedback setting.

● Indicator light meanings

Name	State	Meaning	
Unit indicator light	Hz	Spark	Digital display given frequency.
	Hz	On	Digital display output frequency.
	A	On	Digital display actual output current.
	V	On	Digital display input voltage.
	V	Spark	Digital display output voltage.
	S	On	Time unit is second.
	S	Spark	Time unit is ms, min, or h.
	RPM	On	Digital display motor speed.
	%	Spark	Digital display given PID.
	%	On	Digital display PID feedback.
State indicator light	FWD	On	Inverter is forward rotating.
	FWD	Spark	Inverter is reverse rotating.
	FWD	Off	Inverter stops.
Function indicator light	REV/JOG	On	Jog.
	REV/JOG	Off	Reverse.

















Chart 4-1: Indicator light meanings

● Number and character table

Number, character	LED display	Number, character	LED display	Number, character	LED display
0	0	C	0	O	0
1	1	D	2	P	8
2	2	E	8	Q	8
3	3	F	8	R	8
4	4	G	0	S	8
5	5	H	8	T	8
6	6	I	8	U	8
7	0	J	0	V	0
8	8	K	8	W	00
9	9	L	8	X	No display
A	8	M	00	Y	4
B	8	N	8	Z	No display

Chart 4-2: Number and character table

● LED keyboard stamp explain:

Stamp	Explain
	Frequency inverter stop
	FWD
	REV
	JOG
	REV second stamp
	Remind press  key
	Remind press  key
	Cursor can up or remind up
	Cursor can down or remind down
	It flashing means fault
	Arrowhead direction
	Terminal not connect
	Terminal connect
	Two relay output: one on, another off

4.3 Basic Operation

4.3.1 Menu Structure and Operation

AC70 series frequency inverter parameter setting adopts 3 groups of menus which can be checked and modified easily. Three menus are basic parameter, external terminal parameter and special function parameters. Operation method:

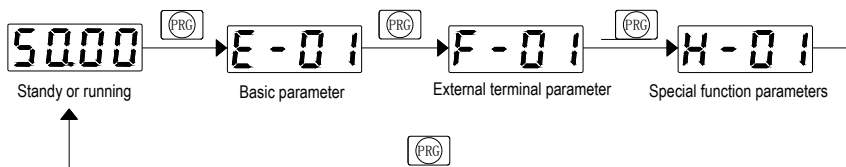

Chart 4-1: FWD/REV and 3 groups of menus switch operation

Note: One line display and dual line display keypad has the same operation process and operation method.

4.3.2 State Display Switching

The LED display kinds of monitor parameters of AC70 series inverter in running or stop mode. User can uses [E-06, E-07] to select specific monitor parameters in one line display keypad, also can uses [E-06, E-07] to select upper line display and lower line display contents in two line display keypad.

User can uses SET and shift key to see specific monitor parameter in one-way circulation in one line display keypad or in two line display keypad. Please refer to following operation flow chart.

1, One line display keyboard cycle switching display.

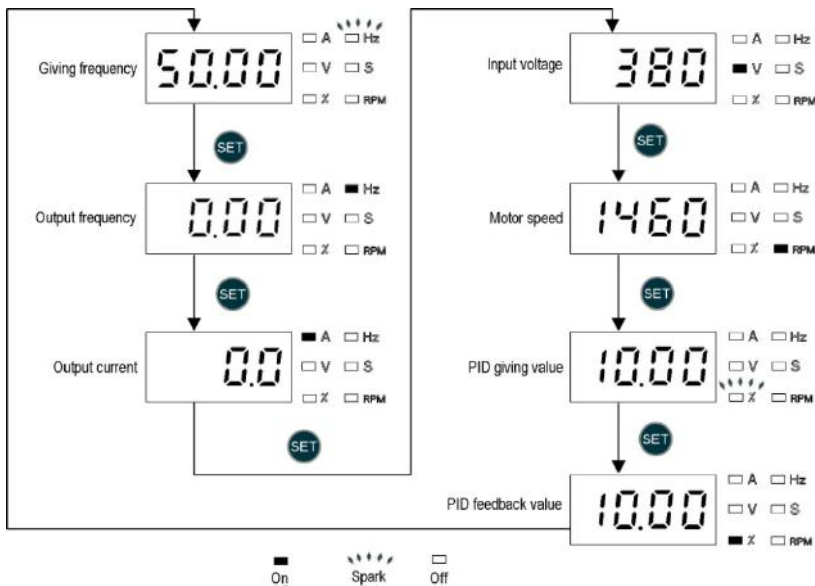
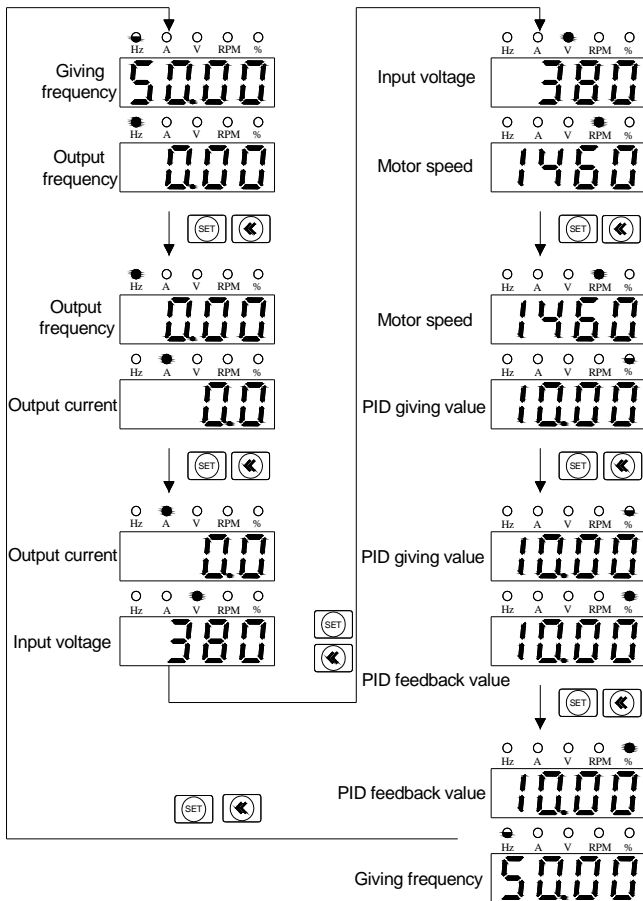

Chart 4-2: One line display keyboard cycle display

2. Dual line keypad cycle switching display monitor parameters operation flow chart.



● On ◐ Spark ○ Off



-  Change first line parameter by cycle
-  Change second line parameter by cycle

Chart 4-3: Dual line display keypad cycle display

4.3.3 Parameter Setting Mode

AC70 series frequency inverter best performance is based on parameter right setting. Here take [F-08] as a sample to show how to set parameter for both small keyboard and big keyboard.

1, Small keyboard set mode

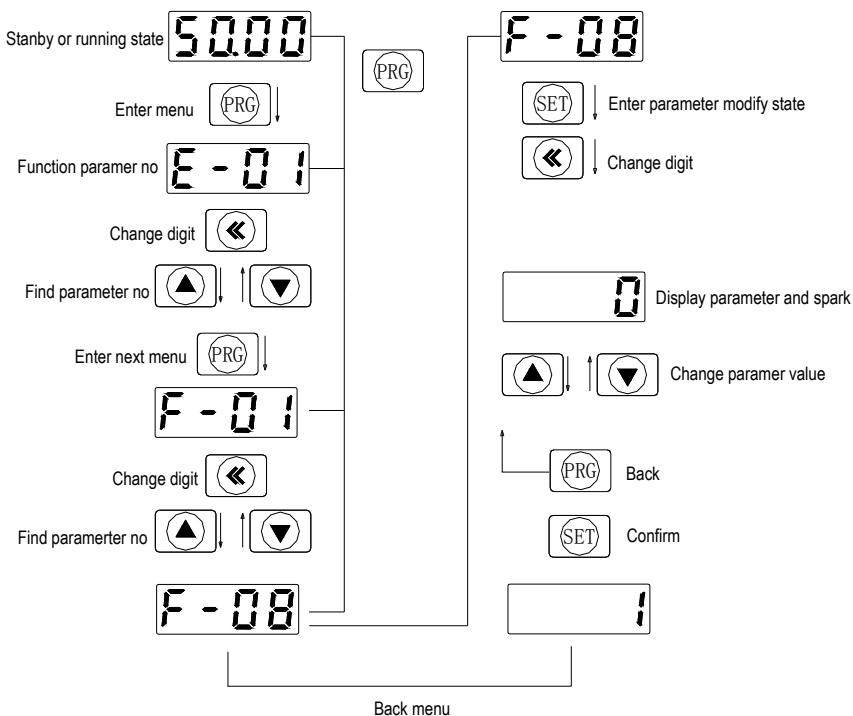

Chart 4-4: Small keyboard parameter set

2, Big keyboard set mode

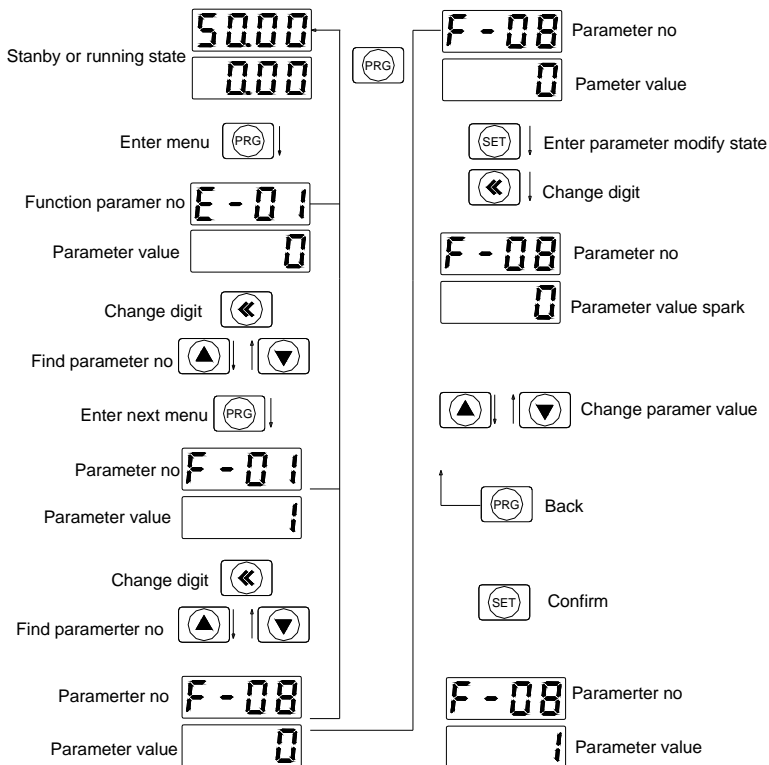

Chart 4-5: Big keyboard parameter set

4.4. Trial Run

● Trial run commissioning guide

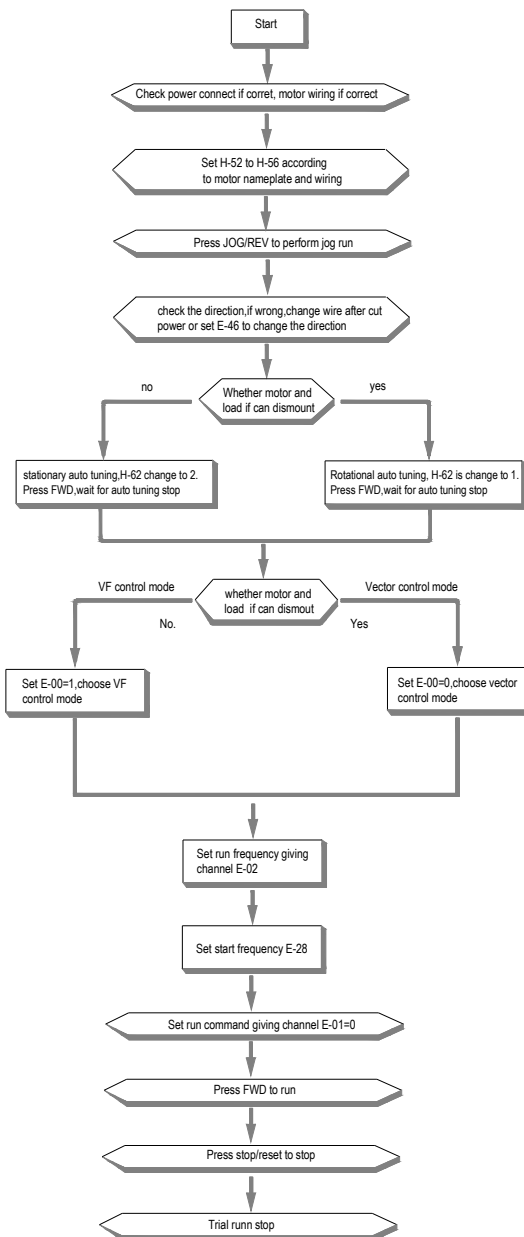

Chart 4-6: Trial run

● Parameter auto-tuning selection

Motor parameter auto-tuning

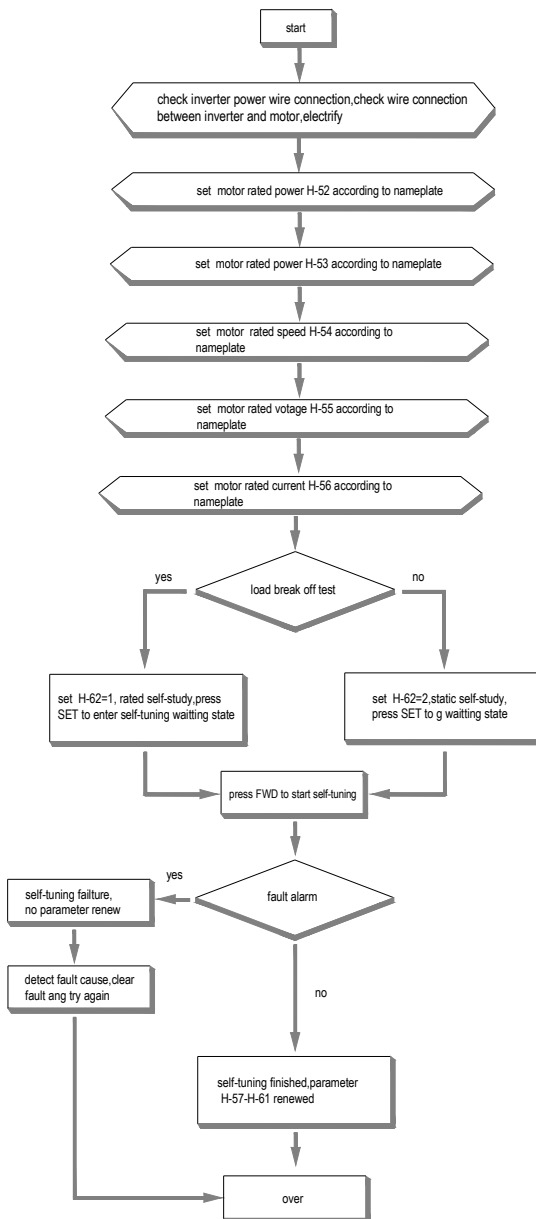

Chart 4-7: Parameter self-tuning selections

● Frequency giving flow

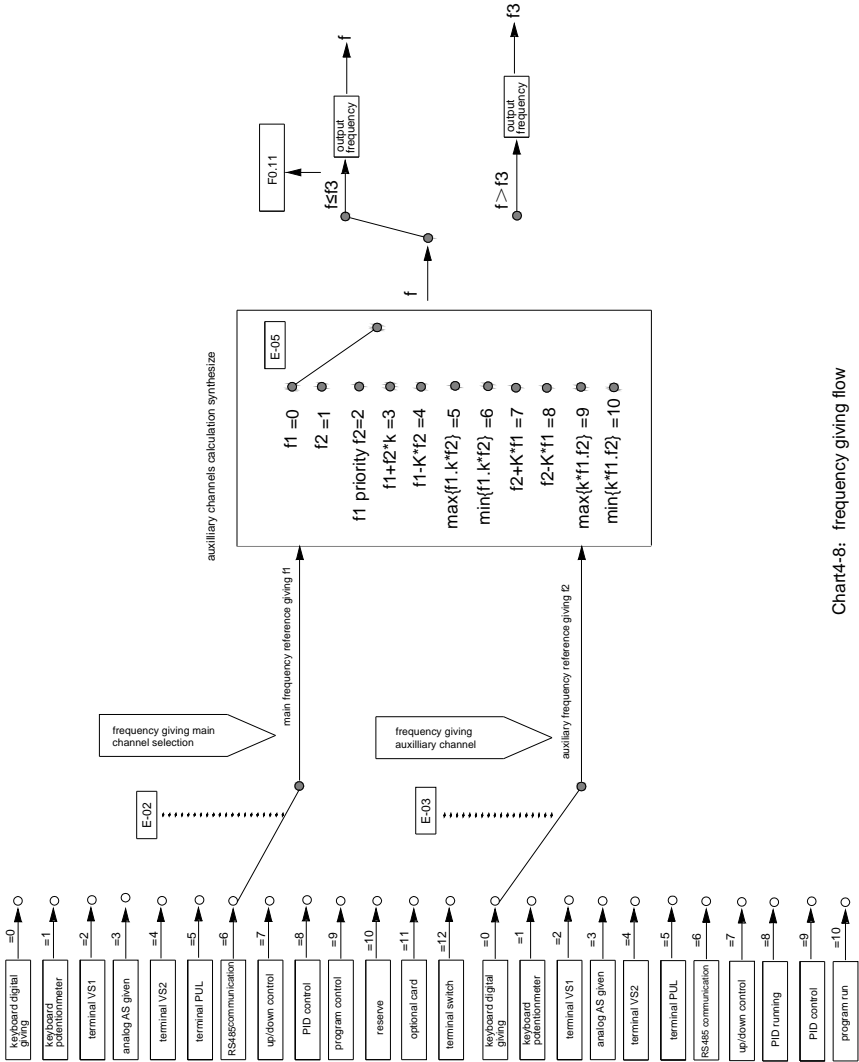

Chart4-8: frequency giving flow

● Start/stop control flow

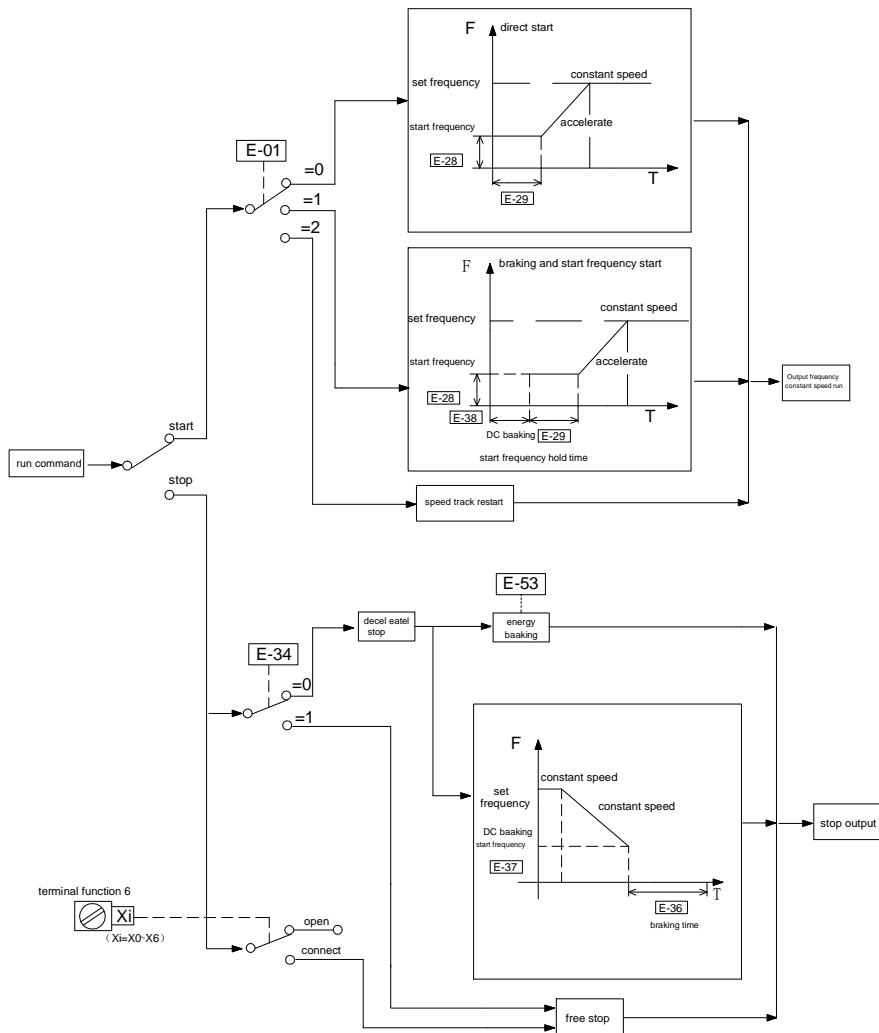

Chart 4-9: Start/stop control flow

● Open-loop VC control (speed mode)

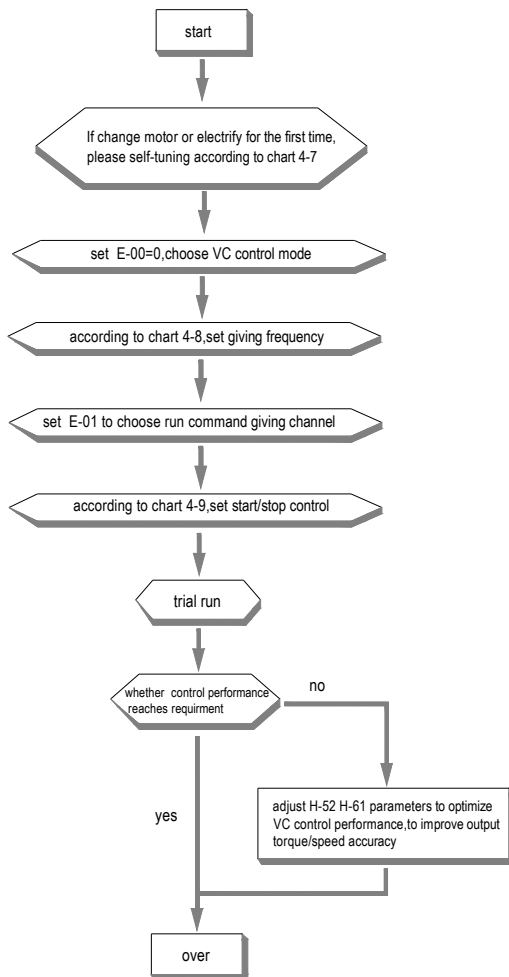

Chart 4-10: Open-loop VC control





Chapter 5: Fault Diagnoses and Processing







This chapter explains the display content and processing of the inverter fault, alarm and operation fault. It also simply explains the bad situation caused by inverter or motor fault and how to solve it. For the adjustment guide in trial run, please refer this chapter too.











5.1 Fault Types

Type	Inverter action while fault happens
Equipment fault	<p>While inverter detection fault, the state likes this:</p> <ul style="list-style-type: none"> ● Keyboard display character showing fault content. ● Inverter stops output. Motor stops free slide. ● While function F-31/F-32 is set as 1(fault output),Y1/Y2 terminals output valid open collector digital output. ● While function F-30 is 1(fault output), TA-TC terminals output open passive digital output. ● While there is fault as OL, OC, SC, OV, UL2, if [E-43] is not 0, the inverter will automatically restart after E-44 setting time.
External fault	<p>In certain application occasions, external related equipments fault signals are considered in the inverter control system as usage of monitoring, protection or switch control. At this time, if one multi function terminal is defied as "external fault", the inverter stops output alarm signal.</p>

5.2 Fault Information and Details

Keyboard display	Fault code	Fault type	Possible causes	Treatment
	L.U.1	Too low voltage while stop	<ul style="list-style-type: none"> ● Power supply is too low ● Voltage detection circuit is abnormal 	<ul style="list-style-type: none"> ● Check input power,clear fault. ● Seek support from factory.
	E.LU2	Too low voltage in run	<ul style="list-style-type: none"> ● Power supply is too low ● Power capacitance is too small, or there is big impact current in the power grid. ● Inner DC main contactor is not connect well 	<ul style="list-style-type: none"> ● Check input power,clear fault. ● Improve power supply. ● Seek support from factory.
	E.oU1	Accel. over-voltage	<ul style="list-style-type: none"> ● Power voltage fluctuation over limit. ● Start when motor is running . 	<ul style="list-style-type: none"> ● Detect power voltage and clear fault. ● Restart motor until it completely stop.Set E-30 as 1or2.
	E.oU2	Decel. over-voltage	<ul style="list-style-type: none"> ● Deceleration time is too short. ● Load potential energy or inertia is too large. ● Power voltage fluctuation over limit. 	<ul style="list-style-type: none"> ● Prolong Deceleration time. ● Reduce load inertia or improve inverter capacitance or add braking unit. ● Detect power voltage and clear fault.
	E.oU3	Constant speed over-voltage	<ul style="list-style-type: none"> ● Power voltage fluctuation over limit. 	<ul style="list-style-type: none"> ● Detect power voltage and clear fault. ● Install input reactor.

	E.oU4	Over-voltage while stop	<ul style="list-style-type: none"> ● Power voltage fluctuation over limit. 	<ul style="list-style-type: none"> ● Check input power,clear fault. ● Seek support from factory.
	E.oC1	Accel. over-current	<ul style="list-style-type: none"> ● Acceleration time is too short. ● Start running motor. ● V/F curve setting is not suitable.Or torque boost too high. ● Inverter capacitance is too small. 	<ul style="list-style-type: none"> ● Prolong acc time. ● Restart motor until it totally stop.Set E-30 as 1or2. ● Reset V/F curve or torque boost value. ● Select inverter with right capacitance.
	E.oC2	Decel. over-current	<ul style="list-style-type: none"> ● Deceleration time is too short. ● Load potential energy or inertia is too large. ● Power voltage fluctuation over limit. 	<ul style="list-style-type: none"> ● Prolong Deceleration time. ● Connect external braking resistance or braking unit. ● Select inverter with right capacitance.
	E.oC3	Constant speed over-current	<ul style="list-style-type: none"> ● Sudden load change. ● Power grid voltage is too low. 	<ul style="list-style-type: none"> ● Check load change and clear it. ● Check input power,clear fault.
	E.oL1	Motor over-load	<ul style="list-style-type: none"> ● V/F curve setting is not suitable. Or torque boost too high. ● Power grid voltage is too low. ● incorrect overload protection setting. ● Locked-rotor run or too heavy load. ● Universal motor long time low speed run. 	<ul style="list-style-type: none"> ● Reset V/F curve or torque boost value. ● Check input power,clear fault. ● Unreasonable H-56 setting. ● Adjust load or select inverter with right capacitance. ● If need long time low speed run,please choose special motor for inverter.
	E.oL2	Inverter over-load	<ul style="list-style-type: none"> ● Load is too heavy. ● Acceleration time is too short. ● Start running motor. ● V/F curve setting is not suitable.Or torque boost too high. 	<ul style="list-style-type: none"> ● Select inverter with right capacitance. ● Prolong acceleration time ● Restart motor until it totally stop.Set E-30 as 1or2. ● Reset V/F curve or torque boost value.
	E. SC	System abnormality	<ul style="list-style-type: none"> ● Acceleration time is too short. ● Short circuit between inverter output phases or earth. ● Module is damaged. ● Electromagnetic disturb. 	<ul style="list-style-type: none"> ● Prolong acceleration time. ● Check periphery equipments and restart after fault cleared. ● Seek support from factory. ● Check system wiring,

				earth, shield and deal as required.
	E.oH	Inverter over-heat	<ul style="list-style-type: none"> ● Temperature is too high. ● Air channel is blocked. ● Fan connection parts is loose. ● Fan is damaged. ● Temperature detection circuit fault 	<ul style="list-style-type: none"> ● Make the environment meeting the requirement. ● Clear the air channel. ● Check and re-connect the wire ● Change the same new fan. ● Seek support from factory.
	E.TE1	Motor static detection fault	<ul style="list-style-type: none"> ● Detection overtime ● Perform static detection while motor is running. ● Capacitance difference is too big between motor and inverter. ● Motor parameter setting mistake. 	<ul style="list-style-type: none"> ● Check motor connection wire. ● Detect after motor stop totally. ● Change inverter model. ● Reset parameter according to nameplate.
	E.TE2	Motor rotation detection fault	<ul style="list-style-type: none"> ● Detect while motor is running. ● Detect with load. ● Detection overtime ● Capacitance difference is too big between motor and inverter. ● Motor parameter setting mistake. 	<ul style="list-style-type: none"> ● Detect after motor stop totally. ● Re-detect without load. ● Check motor connection wire. ● Change inverter model. ● Reset parameter according to nameplate.
	93SE	Memory fault	<ul style="list-style-type: none"> ● Electromagnetic disturb in memory period. ● EEPROM damage. 	<ul style="list-style-type: none"> ● re-input and save. ● Seek support from factory.
	LIFE	Reserved		<ul style="list-style-type: none"> ● Seek support from factory.
	ERR1	Input phase missing	<ul style="list-style-type: none"> ● 3 input phase missing 	<ul style="list-style-type: none"> ● Check 3phase input power and phase. ● Check 3phase input power wiring.
	ERR2	Output phase missing	<ul style="list-style-type: none"> ● 3 phase output of inverter missing connection with motor 	<ul style="list-style-type: none"> ● Check wire between inverter and motor, earth and motor insulation.
	ERR3	Current detection fault	<ul style="list-style-type: none"> ● Detect circuit fault. ● Phase imbalance 	<ul style="list-style-type: none"> ● Seek for technique support. ● Check motor and wiring.
	ERR4	Inverter external fault	<ul style="list-style-type: none"> ● Peripheral equipment fault protection. 	<ul style="list-style-type: none"> ● Check peripheral equipment.
	ERR5	Swing frequency fault	<ul style="list-style-type: none"> ● User not set right swing frequency running parameter. 	<ul style="list-style-type: none"> ● Set parameter again.







	ERR6	Keyboard connect fault	<ul style="list-style-type: none"> ● Keyboard wire fault. ● Keyboard component damage. 	<ul style="list-style-type: none"> ● Check keyboard wire ● Seek support from factory.
	E.CPE	Parameter copy fault	<ul style="list-style-type: none"> ● Parameter copy communication is fault. ● Copy keyboard is not match the inverter. 	<ul style="list-style-type: none"> ● Check wire. ● Select the specified external keyboard model.
	E.CE	RS485 communication fault	<ul style="list-style-type: none"> ● Baud rate not right. ● Communication connection not right. ● Communication format not right. 	<ul style="list-style-type: none"> ● Set right Baud rate ● Check communication wiring ● Check Communication format
	SEn	Feedback sensor fault	<ul style="list-style-type: none"> ● Alarm while PID analog value feedback signal is small than [H-28]. ● PID feedback wire problem. ● Feedback sensor problem. ● Feedback input circuit problem. 	<ul style="list-style-type: none"> ● Confirm sensor state, change it if problem ● Check wiring. ● Adjust feedback channel signal
	E.PAn	Keyboard connect fault	<ul style="list-style-type: none"> ● Keyboard wire fault. ● Keyboard component damage. 	<ul style="list-style-type: none"> ● Check keyboard wire ● Seek support from factory.
	E.EF	Inverter external fault	<ul style="list-style-type: none"> ● Peripheral equipment fault protection. 	<ul style="list-style-type: none"> ● Check peripheral equipment.
	E.PAn	Keyboard connect fault	<ul style="list-style-type: none"> ● Keyboard wire fault. ● Keyboard component damage. 	<ul style="list-style-type: none"> ● Check keyboard wire ● Seek support from factory.

Chart 5-1: Fault information and details

5.3 Fault Diagnoses Process

System fault diagnoses process

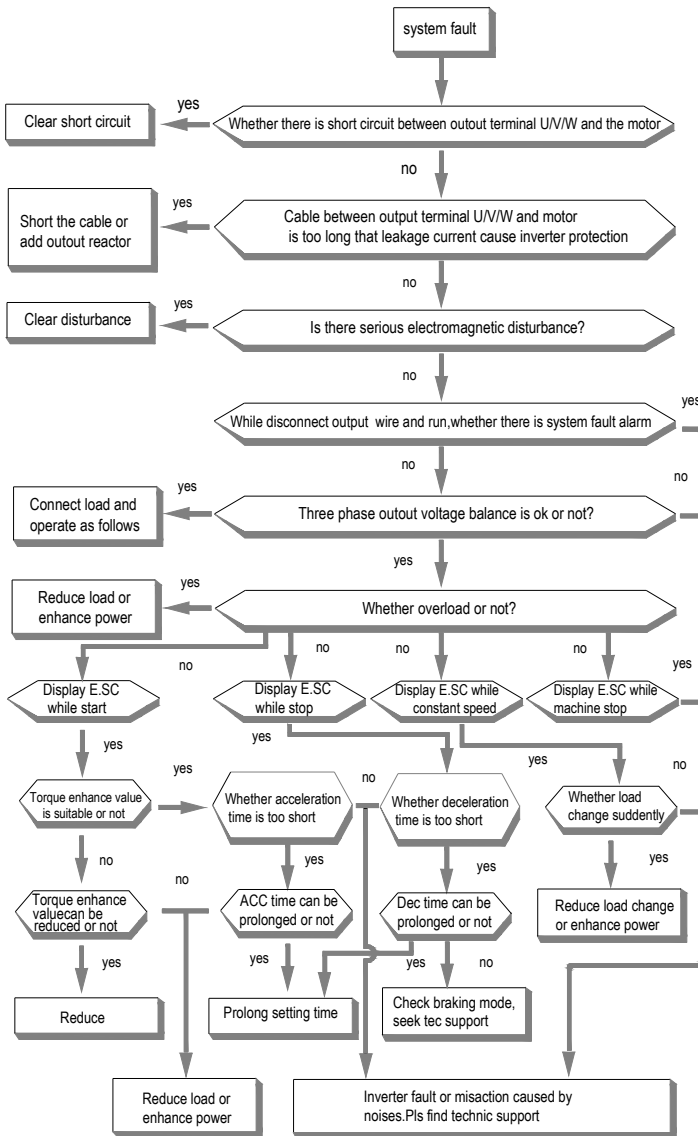

Over current diagnoses process

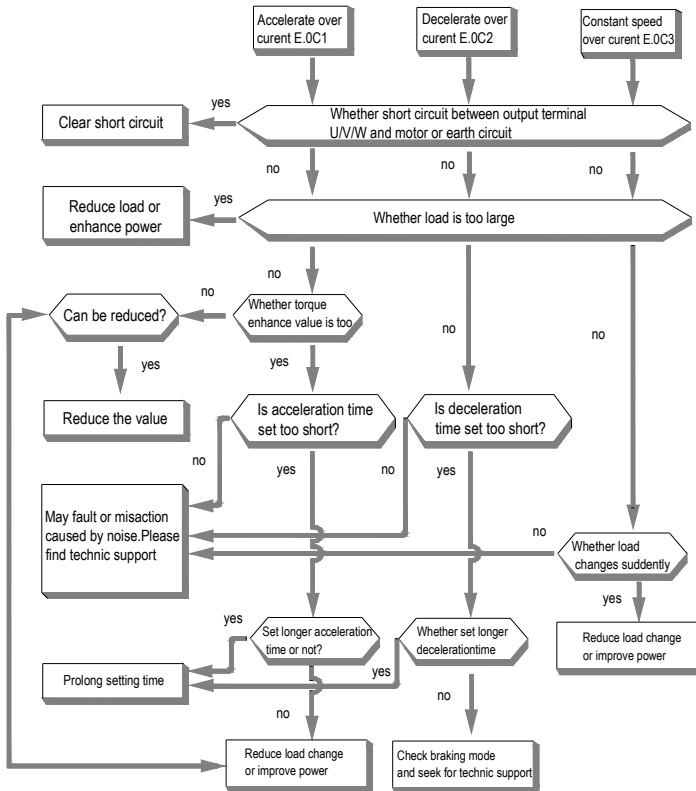

Over voltage diagnoses process

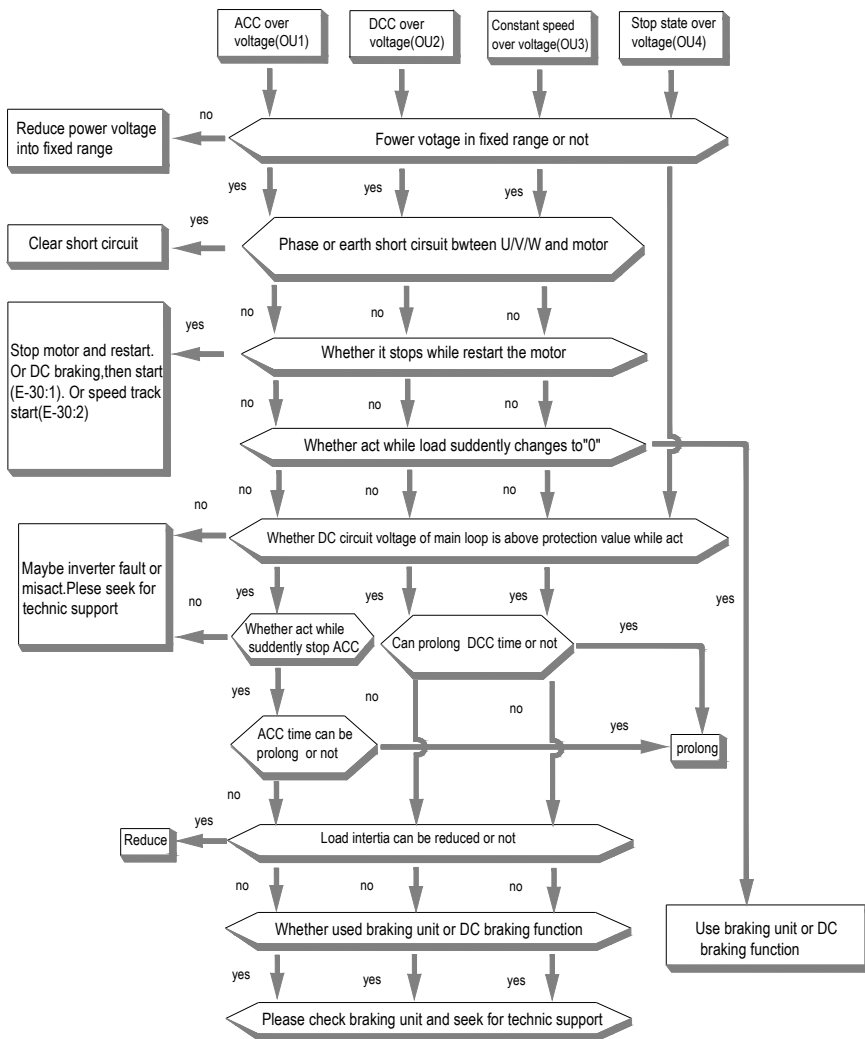

Supply voltage is too low

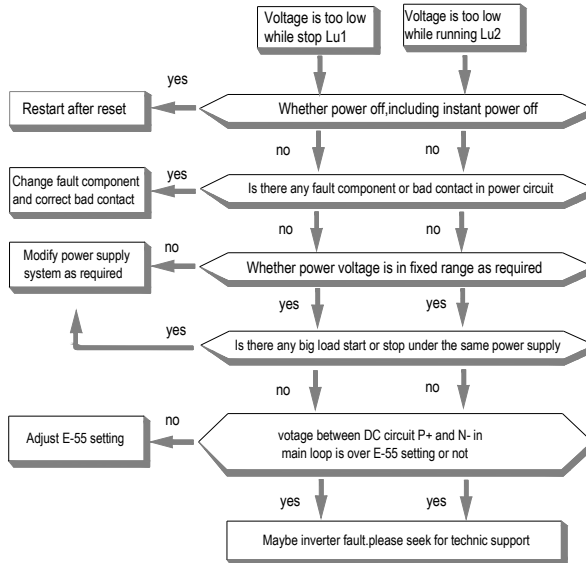

Inner inverter over heat

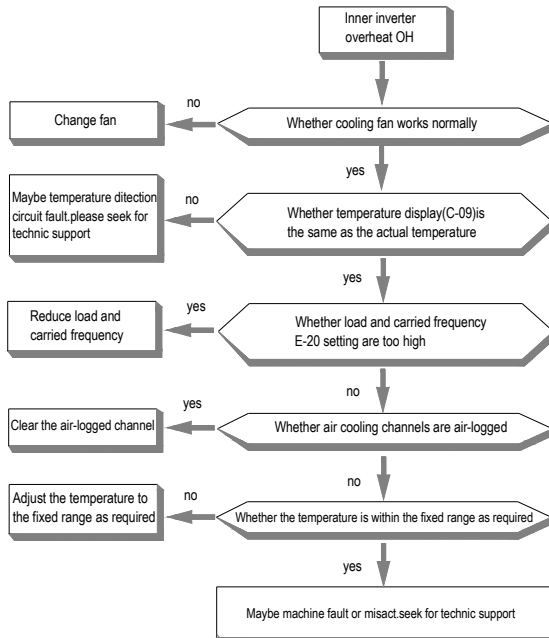

Over load

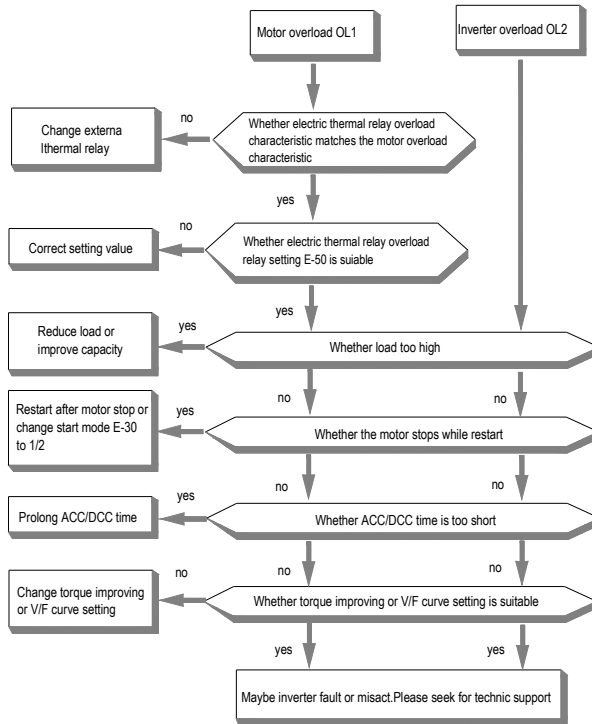

No display

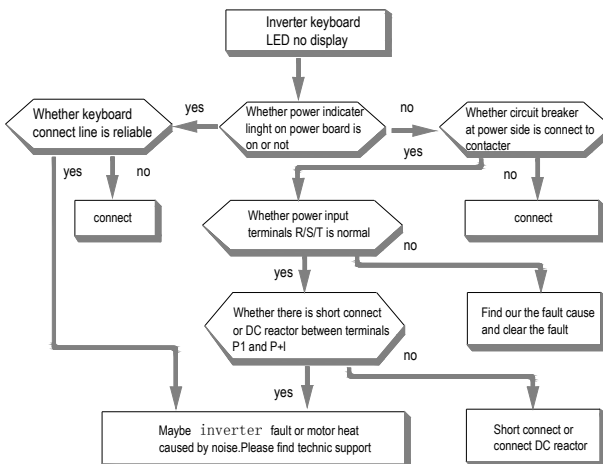

Motor heat

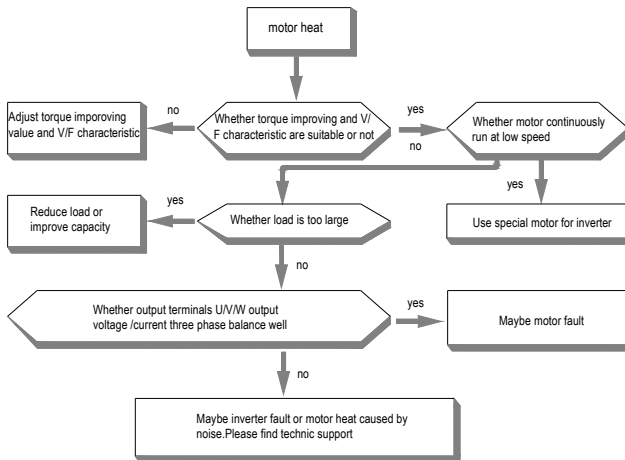

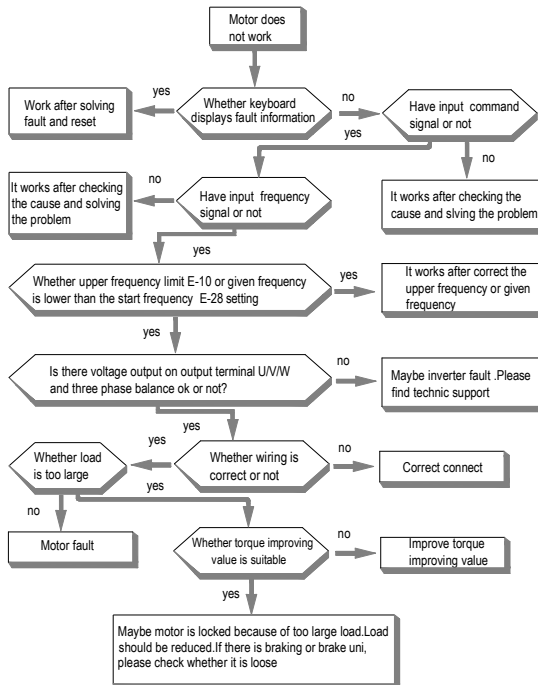

Motor does not rotate



Chapter 6: Periodic Overhaul and Maintenance

6.1 Safety Precautions

This chapter explains the safety rules in overhaul and maintenance.

	<ul style="list-style-type: none"> ● No operation under power connected state. Otherwise there is danger of electric shock death. ● Before operation, please cut all related equipments power, ensure that the main circuit DC current has dropped to safe range. And please operate after 5 mins.
	<ul style="list-style-type: none"> ● No operation while cover/panel is dismantled. Otherwise there is danger of electric shock death. ● Do not dismantle the cover or PCB under power connected state. Otherwise there is danger of electric shock death. ● Only professional person can maintain or change fittings. Otherwise there is danger. ● Do not wear loose clothes while install, debug, maintain. Rated protective tools and safeguard should be adopted. ● Tighten screw according to named moment. If main circuit wire connection is loose, there is danger of overheat fire. ● Machine and motor earth must be reliable. Otherwise there is danger of electric shock if touches the cover.
	<ul style="list-style-type: none"> ● While operation, please follow the ESD regulations. Otherwise the inverter maybe damaged. ● Do not change the circuit or structure of the inverter. Otherwise the inverter maybe damaged. ● Please confirm the rotate direction while no-load. Wrong direction can bring body injury or huge wealth loss. ● Do not use damaged machine. Otherwise there is danger of accident.

6.2 Overhaul

Frequency inverter is composed by semi-conductive component, passive electronic component and motive component. All of these components have useful life. Even under normal working environment, some of the components can not work after the life time. To avoid malfunction, daily checking, periodic overhaul, component changing and other maintenance should be carried out to prevent. We suggest one overhaul every 3-4 monthes after installation. The overhaul period should be shorter while under cases as below.

High temperature, high altitude;

Start and stop frequently;

AC power supply or load fluctuates badly;

With bad wave or impact;

With dust, metal dust, salt, vitriol, chlorine;

Bad store condition;

- Daily checking

To avoid machine damage and to prolong life time, please check the following items every day.

Items	Checking content	Treatment
Power supply	Check if power supply meets the requirement and whether there is lack-phase.	Treat it as nameplate explains.
Surroundings	Check whether it meets the table3-1 requirement.	Make sure the problem and solve it.
Cooling system	Check whether the inverter or the motor heat or change color abnormally and cooling fan working state.	Check whether it overload. Tighten screw. Check whether cooling fan is dirty or rotate block.
Motor	Check if there is abnormal vibration or noise.	Tighten machine and electric connection and lubricate the machine components.
Load	Check whether output current is over the rated value of the motor or the inverter and have lasted for a period.	Make sure whether it overload and whether the machine model is right.



: No operation under power connected state. Otherwise there is danger of electric shock death. Before operation, please cut all related equipments power, ensure that the main circuit DC current has dropped to safe range. And please operate after 5 mins.

● Periodic overhaul

Under normal state, one overhaul every 3 or 4 months is ok. Please confirm the actual overhaul period according to the machine use condition and work circumstance while using the machine.

Main circuit

Items	Checking content	Treatment
Whole body	Check insulated resistance; Check circumstance.	Tighten and change bad component; Clear and improve circumstance
Electric connection	<ul style="list-style-type: none"> ● Check whether the wire and connector color changes, whether there is disrepair , crack color change or aging in insulated layer. ● Check whether the connect terminals are damaged or loose. ● Earth checking. 	<ul style="list-style-type: none"> ● Change bad wire. ● Fasten terminals and change bad terminals. ● Measure earth resistance and fasten earth terminals.
Mechanical connection	<ul style="list-style-type: none"> ● Check if there is abnormal vibration or noise or something is loose. 	<ul style="list-style-type: none"> ● Tighten, lubricate and change the bad machine components.
semi-conductive component	<ul style="list-style-type: none"> ● Check whether there is dust or rubbish. ● If there is obvious out change? 	<ul style="list-style-type: none"> ● Clear ● Change damaged component
Electrolytic capacitor	<ul style="list-style-type: none"> ● Whether there is liquid leak, color change, or creak? Whether there is safety valve outcrop, inflation, creak or liquid leak. 	<ul style="list-style-type: none"> ● Change damaged component
Peripheral equipment	<ul style="list-style-type: none"> ● Peripheral equipment outlook and insulation checking. 	<ul style="list-style-type: none"> ● Clear and change damaged component
PCB	<ul style="list-style-type: none"> ● Bad smell, color change, bad rust and connector checking. 	<ul style="list-style-type: none"> ● Fasten connector ● Clear PCB ● Change bad PCB
Cooling system	<ul style="list-style-type: none"> ● Check whether the fan is damaged or blocked up. ● Whether rubbish and dust is stucked to the heat sink . ● Is air inlet/outlet blocked? Or is there something sticking to the inlet/outlet. 	<ul style="list-style-type: none"> ● Clear ● Change damaged component
Keyboard	<ul style="list-style-type: none"> ● Whether is it damaged? Check whether display is complete. 	<ul style="list-style-type: none"> ● Change damaged component
Motor	<ul style="list-style-type: none"> ● Check if there is abnormal vibration or noise. 	<ul style="list-style-type: none"> ● Tighten machine and electric connection and lubricate the machine components.



: No operation under power connected state. Otherwise there is danger of electric shock death. Before operation, please cut all related equipments power, ensure that the main circuit DC current has dropped to safe range. And please operate after 5 mins.

6.3 Maintenance

All equipments and components have useful lifetime. Right maintenance can prolong the lifetime. But it can not avoid damage. Please change the components before their lifetime over.

Component	Useful lifetime
Fan	2~3year
Electrolytic capacitor	4~5 year
PCB	8~10 year

- Fan

While changing fan, please use original fan. You can contact Veichi company or the dealer. There are inverter models with many fans in one machine. To prolong these machines lifetime, you had better change all fans while changing the cooling fan.

- Fan change method:

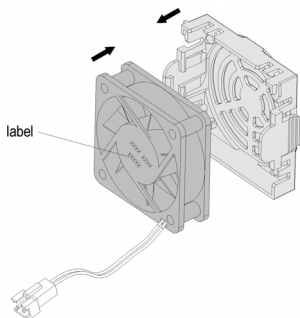

1, Install the fan vertically into the cover as shown in the picture (the label should face the outside).

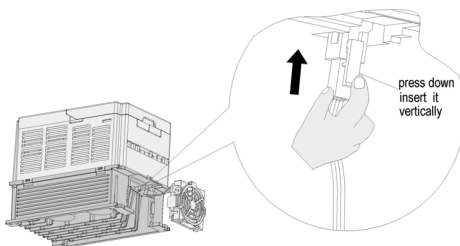

2, Press the elastic clip of the fan by finger toward the inner side and insert the leading terminal of the fan vertically by a little strength.

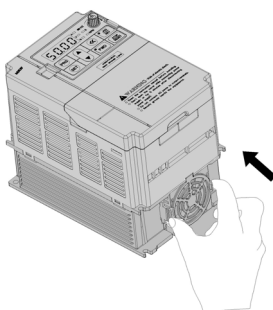

3, Insert the two elastic clips of the fan cover vertically into the fan installation slots.

● Fan dismantlement:

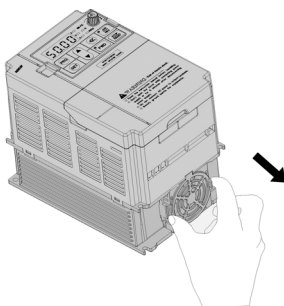

1, Pinch the two elastic clips of the fan and pull out. Then dismantle the fan cover.

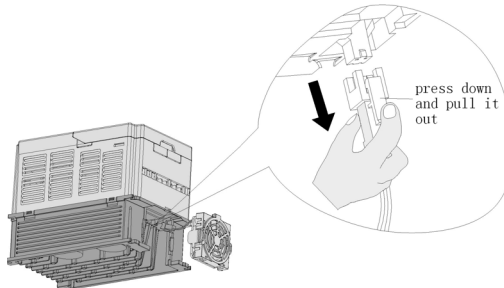

2, Press the elastic clip of the fan by finger toward the inner side and pull out the leading terminal of the fan vertically by a little strength.

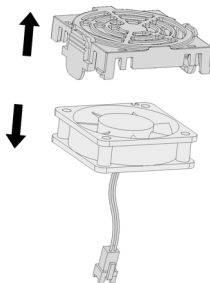

3, Poke the clips toward the outside and detach the fan from the cover by a little strength.



: 1, No operation under power connected state. Otherwise there is danger of electric shock death. Before operation, please cut all related equipments power, ensure that the main circuit DC current has dropped to safe range. And please operate after 5 mins.

2, While the inverter is working, the heat sink temperature will be higher as the consumption. To prevent from scald, please do not touch the heat sink and do not change the fan until the temperature being safe.

3, To ensure the best performance of the inverter, please use the original fan.



●Other components

The replacement of the other components has strict requirements on maintenance technique and product familiarity. And they can not be used without strict detection after replacement. So we do not suggest the user to replace the other inner components. If they need to change indeed, please contact to the dealer or the sales department of Veichi electric company.

Chapter 7: Peripheral Equipments and Options



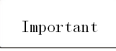

7.1 Safety rules









User must obey to the following safety rules and related requirements while using the peripheral equipments and options.

	<ul style="list-style-type: none"> ● No operation under power connected state. Otherwise there is danger of electric shock death. ● Before operation, please cut all related equipments power, ensure that the main circuit DC current has dropped to safe range. And please operate after 5 mins.
	<ul style="list-style-type: none"> ● No operation while cover/panel is dismantled. Otherwise there is danger of electric shock death. ● Do not dismantle the cover or PCB under power connected state. Otherwise there is danger of electric shock death. ● Only professional person can install, debug or maintain the peripheral equipments and options. Otherwise there is danger. ● Do not wear loose clothes while install, debug, maintain. Rated protective tools and safeguard should be adopted. ● Do not change wire, dismantle jumping wire, optional card, or change cooling fan while the inverter is running. Otherwise there is danger of electric shock death. ● Tighten screw according to named moment. If main circuit wire connection is loose, there is danger of overheat fire. ● Earth of the peripheral equipments and options must be reliable to prevent human body injury.
	<ul style="list-style-type: none"> ● While operation, please follow the ESD regulations. Otherwise the inverter may be damaged. ● Do not cut the power supply while the inverter is outputting voltage. Otherwise the inverter may be damaged.

7.2 Peripheral Equipments

Normal peripheral equipments are showed as below. To order the peripheral equipments, please consult our dealer or sales department.

Peripheral equipment		Functions
	Breaker	Protect power system and prevent malfunction impact other equipments working when short-circuit happens. And over-load protection.
	Leakage current breaker	Earth protection prevent electric shock(suggest to use the type which can prevent high-frequency leakage current)
	Electromagnetic contactor	Separate power and inverter indeed and realize basic relay control.
	AC input reactor	Improve power side factor and isolate the noise disturbance to the frequency inverter from the power side.
	DC reactor	Restrain ultra harmonics and improve power factor.

	Input side noise filter	Reduce frequency inverter disturbance to the power and reduce the power grid disturbance.
	Braking resistor	Passive energy consume unit of electric braking.
	Consumption braking unit	Electric braking control unit, controlling the braking resistance consume the regenerated electric power of the motor efficiently.
	Output side noise filter	Reduce the output side wire electromagnetic disturbance.
	Standby system	Standby system for inverter malfunction.
	Heat relay	Protect the motor while over load.
	0-phase reactor	Reduce electromagnetic disturbance of the frequency inverter (suitable for input/output side).
	Main loop surge absorbable unit	Restrain surge voltage while main loop switch components act.
	Winding surge absorbable unit	Restrain surge voltage when the AC contactor acts.

7.3 Use of Peripheral Equipments

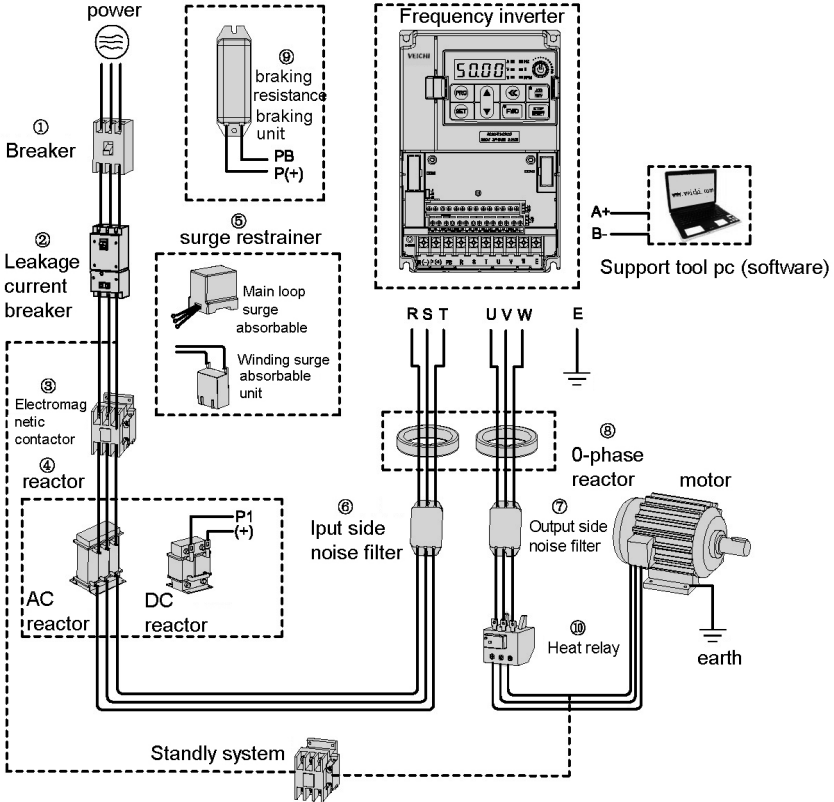

Chart 7-1:Peripheral equipments connection fig

Note:

Wiring breaker

To ensure wiring safe, protect power system and prevent malfunction expand to impact other equipment working while short-circuit happens, and protect while over-load, please do use wiring breaker between power supply and main loop power input terminals R,S,T.

Caution: While choosing the breaker, the capacitance should be 1.5-2 times of the rated output current of the frequency inverter. Please compare the time characteristic and protective time to the inverter (150% of the rated output current, one minute). Make sure there will be no skip.

Warn: Before main loop wiring, make sure to cut the breaker and electromagnetic contactor. Otherwise there is danger of electric shock.

Leakage current breaker

The frequency inverter outputs peak voltage high-speed switch square wave. So there is high-frequency leakage current. For earth protection to prevent electric shock and leakage current fire, please install leakage current breaker. Usually, one set frequency inverter will bring 100mA leakage current (while the power cable length is 1m). If the length prolongs 1m, there will be 5mA more leakage current. So please use leakage current breaker special for high frequency leakage at the power input side of the frequency inverter. The factors which impact leakage current are as below:

Capacitance of inverter

Carrier frequency

Motor cable type and wire length

MI/RFI filter

To protect human body and inverter, please choose leakage current breaker which can use AC/DC power and can face high frequency leakage current. There should be one leakage current breaker with more than 200mA sensitive current for every frequency inverter. If the frequency inverter outputs different wave, the high frequency leakage current can be higher, which will lead to breaker fault. In this case, please take below treatments:

Improve the sensitive current of the leakage current breaker

Reduce the carrier frequency of the inverter

Electromagnetic contactor

Electromagnetic contactor is a peripheral equipment what is set to actually separate power and inverter connection.

While inverter protective function is acting or carrying out emergency stop operation, the main loop power can be cut by peripheral equipment. Please do not connect the electromagnetic switch or electromagnetic contactor to output circuit.

Otherwise the inverter may be damaged. While the power recovers after instant stop, if it needs to prevent the inverter to auto-restart, please install electromagnetic contactor for control at the input side.

AC input reactor and DC reactor

To restrain current sharp change and high hypo harmonic current, it needs to use AC input reactor and DC reactor. It can also improve power factor at the input side. In the following cases, AC input reactor or DC reactor must be used (use both will bring better effect).

Need to restrain high hypo harmonic current and improve power side factor;

Need to switch input phase capacitance;

Frequency inverter is connected to large capacitance power transformer (600kVA above);

Silicon-controlled converters such as DC motor driver are connected to the same power system.

If user has higher requirement on other harmonic restraint, please connect the external DC reactor. Before connect the external DC reactor, make sure to dismantle the short connector between the terminals P1 and (+).

Surge restrainer

Surge restrainer is divided into winding surge restrainer and main loop surge restrainer according to the use position.

Pls choose the right one which is suitable for the occasion. The aim of surge restrainer installation is to restrain the surge voltage brought by switch components such as inductive load which is surrounding the frequency inverter

(electromagnetic contactor, electromagnetic relay, electromagnetic valve, electromagnetic winding). Do not connect the surge restrainer to the output side of the frequency inverter. Otherwise the frequency inverter will be damaged. .

Input side noise filter

Rectifier bridge of the inverter is uncontrolled rectifier bridge. And input current is discontinuous impulse current. So the harmonic current noise signal, which flows to power wire from the inverter inner, may bring bad impact on the surrounding machines (radio, phone, non contact switch, sensor). This time, we suggest to install input side noise filter to lighten the noise into the power wire. Besides, it can also reduce noise from the power wire into the frequency inverter.



: Please use the noise filter special for the frequency inverter and the connection wire between the filter and the inverter should be as short as possible.

Output side noise filter

The frequency inverter outputs square wave with high-speed peak value voltage switch. So there is high-speed dv/dt converter on the output cables that will produce a large number of radio disturbance and inductive signal. By installation noise filter at the output side, the impact can be relieved. Please do not install the input-phase capacitance and the noise filter to the output circuit. Otherwise there is danger of damage to the frequency inverter.

0-phase reactor

0-phase reactor is used to reduce the electromagnetic inductive disturbance of the frequency inverter, which is suitable for the input side and output side. It equals to a three-phase common mode inductance. In actual use, according to the actual magnetic core size and cable specification, it is better to make sure 3-5 circles winding ratio to bring the best performance.

Braking reactor or braking unit

Renewed power consumption unit, please see the sixth part of the chapter three "electric installation".

Heat relay

Please install the heat relay at the output side of the frequency inverter. When the motor enters into overload state, it will cut the power source to protect the motor. While using one frequency inverter to run one motor, there is no need to install heat relay. The motor overload protection current [E-49] of the frequency will work. While using one frequency inverter to run multi-motors or the motor is run directly by the power grid, please install heat relay between the frequency and the motor. While installing the heat relay, please design to cut the sequence control circuit of the MC at the main loop input side by the connection spot of the relay or design to input the heat relay action into the frequency inverter as the exterior malfunction. And please pay attention to the following tips to avoid heat relay fault and motor overheating at low speed.

Run at low speed

One frequency inverter run multi motors

Motor cable is very long

Detect malfunction mistakenly for carrier frequency is too high

Low speed and heat relay

In normal case, the heat relay is suitable for the universal motor. While using the frequency inverter to run the universal motor (standard motor), the motor current is 5-10% bigger, comparing with the commercial power supply. Besides, at low speed, even in the motor rated current range, the cooling capability of the fan driven by the motor axis will reduce, which will bring motor overheat. So please set the motor overheat protection current [E-49] in the frequency inverter to be valid.

Motor cable is very long

While the motor cable is very long and the carrier frequency is very high, impacted by the leakage current, the heat relay may fail. To avoid it, please reduce the carrier frequency or set higher detection value of the heat relay. Before enhancing the detection value, do confirm whether there is other cause for the motor overheat. Otherwise there is danger.

Chapter 8: Function Parameters Specification

8.1 Basic Parameters Specification

E-00	control method selection	range:0-1	Default: 1
------	--------------------------	-----------	------------

0: Open loop vector control without PG Also call sensorless vector control mode, are suitable for application one inverter drive one motor which need high performance control requirement. It can achieve fast torque response, wide speed control range and high torque output even under low speed without motor feedback.

Note: It needs to perform motor auto tuning with configure motor parameters correctly before first time running with this control mode.

1: V/F control mode Adjusting the speed with V/F ratio, Use this mode for simple speed control and for multiple motor applications with low demands to dynamic response or speed accuracy. This control mode is also used when the motor parameters are unknown and Auto-Tuning cannot be performed. The speed control range is 1:40.

E-01	Running control command channel selection	Setting range:0-2	Default: 0
------	---	-------------------	------------

Uses for selecting inverter running, stop and running direction command input channel.

0: Operator keypad Running and stop of inverter control by forward running key FWD, reverse running or Job key REV/JOG and stop key STOP/RESET of operator keypad. When **[E-08]** parameters set to 0, REV/JOG is defined for reverse running, when **[E-08]** parameter set to 1, REV/JOG is defined for JOG running.

1: External terminal control Running, stop and rotation direction of inverter control by ON and OFF of FWD terminal or reverse terminal. Please refer to **[F-08]**.

2: RS485 Communications port control Running, stop and rotation direction of inverter control by given signal of RS485 control port.

Note: STOP/RESET of keypad, reset command from control terminal or RS485 communication are all enabled when fault reset.

Tips: 1. The running direction of inverter control is disabled by this command when programming control and (VS2) terminal input bipolar adjustment, direction control is valid.

2. STOP/RESET key function is programmable, it can be defined emergency stop button function when selecting external terminal control or RS495 control, refer to [F-07]; If use STOP/RESET button on keypad to stop inverter when selecting external terminal control, inverter will be stop and locked the external terminal command, it need to input external terminal stop command to unlock it, and then external terminal running command will be activated again. It is the same for RS485 communication control.

3. When selecting operator keypad control, direction control by external terminal takes is priority to control by keypad; it means that when reverse terminal and COM is on, if the direction command is changed by keypad, it will be keep the same original running direction after the terminal and COM is off.

E-02	Frequency reference given main channel selection	Setting range:0-12	Default: 1
------	--	--------------------	------------

It is used for selecting main frequency reference given of inverter, the frequency given will control or affect the output frequency of inverter; terminal (VS2) analog voltage signal and program control channel also will control the running direction of inverter directly.

0: Operator keypad digital Main frequency reference given by parameters **[E-16]** configuring; it is available to modify the **[E-16]** preset value via up/down arrow button on keypad when inverter in running status or stop state.

1: Potentiometer of keypad Main frequency given is determined by potentiometer of keypad.

2: Terminal VS1 analog voltage 0-10V Main frequency given determined by control terminal VS1 analog input, Regarding the relationship between input analog and frequency, filter time of input analog, Please refer to parameters in detail **[F-41, F-42, F-43, F-56, F-57, F-58]** parameters

3: Terminal AS analog current signal 4-20mA Main frequency given is determined and modified by (AS) analog current input; Regarding the relationship between input analog and frequency, filter time of input analog, Please refer to parameters in detail [F-50, F-51, F-52, F-56, F-57, F-58].

4: Terminal VS2 analog voltage -10-10V Main frequency given is determined and modified by control terminal VS2 analog input, Regarding the relationship between input analog and frequency, filter time of input analog, Please refer to parameters in detail [F-44, F-45, F-46, F-47, F-48, F-49, F-56F, -57, F-58].

5: Pulse train signal Main frequency given is determined and modified by control terminal (PUL) analog input, Regarding the relationship between input analog and frequency, please refer to parameters in detail [F-53, F-54, F-55, F-56, F-57, F-58].

6: RS485 communication port Main frequency given is determined by receiving signal of (A+) and (B-) of RS485 communication port.

7: Up and Down control Main frequency given is determined by increasing UP and decreasing (DOWN) terminal connecting or disconnecting(ON/OFF) with COM terminal; each of multi- terminal (X1-X6) can be programmed by frequency UP terminal and DOWN terminal, refer to [F-01-F-06] in detail; Initial frequency of up and down terminal control can be configured, please refer to parameter [F-07] LED ten digit option and [F-70].

The acceleration and deceleration time of UP and Down control running is determined by acceleration/ deceleration time 1 [E13-E-14] setting; The rate of speed change of Up and Down terminal is determined by acceleration/ deceleration time 2 [F-24-F-25] setting.

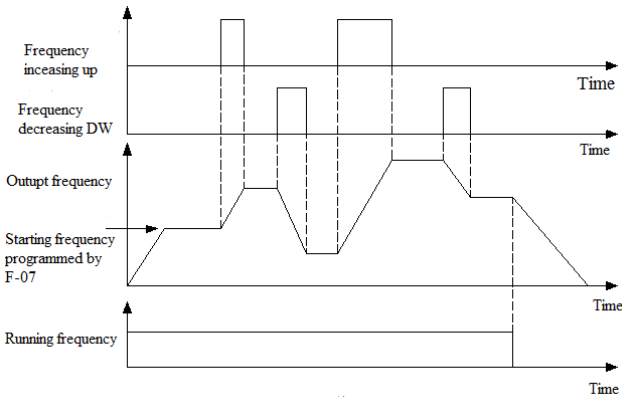

Up and down control diagram

8: General PID operation Select it use to set up general PID close loop control system. When it has been applied, the [H-16] present setting value can be modified by up and down arrow button of keypad.

9: Constant pressure PID control It can be used to set up constant pressure PID control (constant pressure water supply system etc) close loop system, the [H-16] present setting value can be modified by up and down arrow button of keypad.

10: Program running Main frequency given and rotation direction are configured by inverter's inner simple PLC process control. Up to 8 steps speed control is available, more detail refer to [E-13, E-14, F-09-F-16, F-24-F-29, H-32-H-51].

Run and stop command of program running determined by present setting value of running control command selection.

When a step running time is set to 0, it means it will skip over this step when perform the program running. It is easy to set up the steps required of program running.

When [E-46] parameter is set to 2 for forbidding reverse running, inverter will be run at 0 speed when arriving to a step which have been set to reverse running.

Program running and multi-step speed operation are designed to achieve inverter variable-speed operation under certain laws. Among the multi step operation, multi step speed switch over and rotation direction changing are achieved through the different combinations of external multi-step speed terminal with COM terminal ON and OFF. Multi step frequency, operation time, rotation direction can be defined by function parameters. Multi step speed control can be defined by each multi-function terminal, Please refer to [F-01-F-06] parameters.

11: Swing frequency run Output frequency periodically changes by pre-set decel & accel time. This function

is especially applicable to system which speed change vary with before and after the bobbin diameter in textile field.

12: Terminal selection The main frequency given channel programmed by terminal selection, refer to the parameter **[F-01-F-06]**

The relationship between terminal mode and frequency given channel as following table:

Frequency given selection terminal 4	Frequency given selection terminal 3	Frequency given selection terminal 2	Frequency given selection terminal 1	Frequency given channel
OFF	OFF	OFF	OFF	Operator keypad digital
OFF	OFF	OFF	ON	Potentiometer of keypad
OFF	OFF	ON	OFF	Terminal(VS1) voltage signal
OFF	OFF	ON	ON	Terminal (AS) current signal
OFF	ON	OFF	OFF	Terminal (VS2) voltage single
OFF	ON	OFF	ON	Terminal pulse train signal
OFF	ON	ON	OFF	RS485 communication port
OFF	ON	ON	ON	UP/Down control
ON	OFF	OFF	OFF	General PID operation
ON	OFF	OFF	ON	Constant pressure PID control
ON	OFF	ON	OFF	Program running
ON	OFF	ON	ON	Swing frequency run

Tips: Frequency reference terminal valid combinations are 0-11(decimal), if not among this range, output frequency will be 0. The OFF of table stands for corresponding terminal with COM is disconnect, ON stands for corresponding terminal with COM is connect.

E-03	Frequency reference given auxiliary channel selection	Range:0-10	Default: 0
------	---	------------	------------

Used for selecting frequency reference given auxiliary channel. The combination mode of auxiliary and main channel programmed by **[E-05]** parameters

0: Operator keypad digital given Auxiliary frequency given is set by up and down arrow key of keypad or parameters **[E-16]** configuring.

1: Potentiometer of keypad Auxiliary frequency given determined by potentiometer of keypad.

2: Terminal VS1 analog voltage 0-10V Auxiliary frequency given is determined and modified by control terminal VS1 analog input.

3: Terminal AS analog current signal 4-20mA Auxiliary frequency given is determined and modified by (AS) analog current input.

4: Terminal VS2 analog voltage -10-10V Auxiliary frequency given is determined and modified by control terminal VS2 analog input.

5: Pulse train signal Auxiliary frequency given is determined and modified by control terminal (PUL) analog input.

6: RS485 communication port Auxiliary frequency given is determined by receiving signal of (A+) and (B-) of RS485 communication port.

7: Up and Down control Auxiliary frequency given is determined by increasing UP and decreasing DOWN terminal connecting or disconnecting(ON/OFF) with COM terminal; each of multi- terminal (X1-X6) can be programmed by frequency UP terminal and DOWN terminal, refer to **[F-01-F-06]** in detail; Initial frequency of up and down terminal control can be configured, please refer to parameter **[F-07]** LED ten digit option and **[F-70]**.

8: General PID operation Selects it use to set up general PID close loop control system. When it has been applied, the **[H-16]** present setting value can be modified by up and down arrow button of keypad.

9: Constant pressure PID control It can be used to set up constant pressure PID control (constant pressure water supply system etc) close loop system, the **[H-16]** present setting value can be modified by up and down arrow

button of keypad.

10: Program running Main frequency given and rotation direction of inverter are configured by inverter's inner simple PLC process control. Up to 8 steps speed control is available, refer to [E-13, E-14, F-09-F-16, F-24-F-29, H-32-H-52]

Tips: Frequency main channel and frequency auxiliary channel can be set the same channel. In this case, the corresponding relationships between the frequency setting values and input signal are rather special, it need to consider the frequency main channel and auxiliary channel both characteristic at the same time. The combination of main and auxiliary frequency given still limited by upper frequency limit and lower frequency limit.

E-04	Frequency reference given channel gain	Range:0.01-5.00	Default:1.00
E-05	Frequency reference given channel combination mode	Range:0-10	Default: 0

Frequency reference given channel gain: Uses to amplify or lessen the frequency input channel signal. Proportional regulating of frequency given both main and auxiliary channel is available.

Frequency given channel combination mode: Uses for selecting frequency given main channel and auxiliary channel combination. K stands for [E-04] setting value, MAX means takes the bigger among the both channel, MIN means takes the smaller among the both.

0:Main channel is valid, auxiliary channel is invalid.

1:Auxiliary channel valid, main channel invalid

2:Both channel non "0" value valid, main channel priority

3:Main channel + (K × auxiliary channel)

4:Main channel - (K × auxiliary channel)

5:MAX [main channel , (K × auxiliary channel)]

6:MIN [main channel , (K × auxiliary channel)]

7:Auxiliary channel + (K × main channel)

8:Auxiliary channel - (K × main channel)

9:MAX [(K × main channel), auxiliary channel]

10: MIN [(K × main channel), auxiliary channel]

Tips: 1. Terminal (VS2) will be quite special in the multi-channel combination case.

A. When (VS2) terminal don not activate the bipolarity adjustment and direct control function both ([F-48] set to 0), the combination mode determined [E-05] combination mode setting.

B. When (VS2) terminal activate the bipolarity adjustment and direction control function both ([F-48] set to 1), (VS2) terminal frequency given with bipolarity and frequency given in another channel implement signed arithmetic based on the combination mode selected, the absolute value is for frequency given, the signed determine the direction rotation of motor after calculation.

C. When (VS2) activate the bipolarity adjustment but no direction control. ([F-48] set to 2). (VS2) terminal frequency given with bipolarity and frequency given in another channel implement signed arithmetic based on the combination mode selected, the absolute value is for frequency given, the rotation direction depend on the[E-01] Running control command selection.

2. Swing frequency running, jog function and multi-step is disabled combine with auxiliary channel.

E-06	Upper LED monitor selection	Range:0-7	Default:0
E-07	Lower LED monitor selection	Rang:0-7	Default:1

Uses to select the monitoring items displayed in two LED on the keyboard respectively. In the monitoring status, the upper LED monitoring item and the lower monitoring item can be modify directly via SET key and SHIFT key.

0: Frequency reference Given 1: Output frequency 2: Output current 3: Input voltage
4: Output voltage 5: Machine speed 6: PID given 7: PID feedback value

When there is only one LED on the keyboard, it is disable to modify the lower LED monitoring via the [E-07] and SHIFT key.

E-08	REV/JOG key of keypad function selection	Range:0,1	Default: 0
------	--	-----------	------------

Uses to select REV/JOG key of keypad function

0:Reverse This key is defined as reverse key (at this moment, keyboard functional indicator REV / JOG is not light). When the running control command selection is programmed as Operator keypad control, press this key, frequency inverter will perform reverse running.

1: Jog This key is defined as jog running key (at this moment, keyboard functional indicator REV / JOG is light). When the running control command selection is programmed as operator keypad control, press this key, frequency inverter will perform job running.

E-09	Maximum frequency	Range:0.01-600.0Hz	Default:50.00Hz
E-10	Upper limit frequency	Range: lower limit frequency- maximum frequency	Default:50.00Hz
E-11	Lower limit frequency	Range: 0.00-Upper limit frequency	Default:0.00Hz
E-12	Lower limit frequency running mode	Range:0,1	Default:1

Maximum frequency: Maximum frequency of [E-09] is the maximum allowable output frequency of inverter frequency, also is the reference point of acceleration and deceleration time setting.

Upper limit frequency: Output frequency upper limit value which is set base on the highest allowable speed of machine. When the frequency given is higher than upper limit value, the actual running frequency is upper limit frequency.

Lower limit frequency: Output frequency lower limit value of inverter. When the frequency given is lower than lower limit value, the actual speed depend on the [E-12] setting.

Maximum frequency, upper limit frequency and lower limit frequency should be cautiously set base on the nameplate parameter of actual control motor and the need of the running conditions.

Except of upper limit frequency and lower limit frequency, the output frequency while inverter running is limited by parameters setting of start-up frequency, free stop frequency, DC braking stop initial frequency, jump frequency and so on. The relationships between the maximum frequency, upper limit frequency and lower limit frequency is shown as the follow Fig.

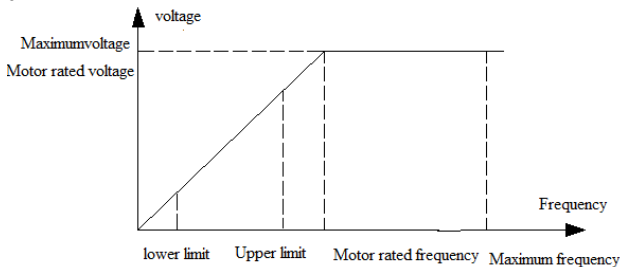

Maximum frequency, upper limit frequency and lower limit frequency relationship. Fig.

Note: Lower limit frequency range is disabled for Jog function, only the upper limit frequency range is enable for Jog function.

If the lower limit frequency operation mode [E-12] set to 0, the frequency given lower than the lower limit frequency, the inverter would be run at 0.

If the lower limit frequency operation mode [E-12] set to 1, the frequency given lower than the lower limit frequency, the inverter would be run at lower limit frequency.

E-13	Acceleration time 1	Range:0.1-6500.0s	Default:※
E-14	Deceleration time 1	Range:0.1-6500.0s	Default:※

Acceleration time 1: when[E-15]LED tens digit place to 1, it defined required time of out frequency accelerates from 0.00Hz to maximum frequency[E-09], when[E-15]tens bit place to 0, it defined required time of output frequency accelerates from 0.00Hz to motor rated frequency, refer to[E-15].

Deceleration time 1: when [E-15] tens digit place to 1, it defined required time of out frequency decelerates from maximum frequency [E-09] to 0.00Hz , when [E-15] tens bit place to 0, it defined required time of output frequency decelerates from motor rated frequency to 0.00Hz, refer to [E-15].

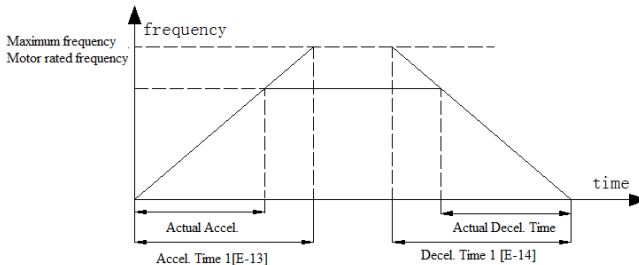

Accel./Decel. time diagram

- Note: 1.** In the general circumstance (no special specify), the acceleration/ deceleration time 1 is default setting. The acceleration time is only valid for normal acceleration running, not including the DC braking starting time and DC braking starting frequency holding time. The deceleration time only for normal deceleration running, not includes DC braking stop time.
2. If activate the equidistant function, inverter would be accelerate base on the accel. time 1, but decelerates based on equidistant stop decel. time setting. Refer to [E-15].
 3. If need apply other accel. & decel. time group, should be configure by control terminals setting, in the program running case, the accel./decel. time 1 is defined for first accel./decel. time, other 3 groups of accel./decel time setting is available, refer to [F-24-F-29]
 4. Jog acceleration and deceleration time are programmed by [E-26, E27]separately.

E-15	Accel/decel mode selection	Range:0000-0111	Default:0000
------	----------------------------	-----------------	--------------

LED unit digit: accelerate /decelerate mode.

AC70 series sensorless vector provide 2 kinds accelerate /decelerate mode, both kinds is enable during normal start, stop, forward and reverse running, accelerate, decelerate process.

0: linear accelerate Suitable for general load.

1: S curve S curve type accelerate/decelerate curve are designed for reducing noise and vibration, reduce starting and stopping shock or decreasing torque required during low speed, accelerate in short time required during high speed.ect during accelerate and decelerate process if need.

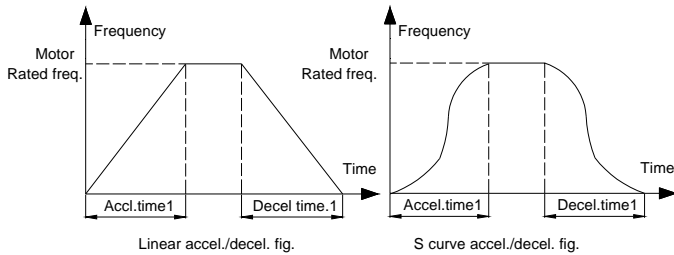

LED tens digit: Accelerate/decelerate time datum point.

0: Motor rated frequency Accelerate and decelerated time base on [H-53] motor rated frequency parameters setting.

1: Maximum frequency Accelerate and decelerated time base on [H-09] maximum frequency setting.

LED hundreds digit: Equidistant stop function

0: Disable

1: Enable

Equidistant stop function: Takes the maximum frequency deceleration time as datum line, the inverter stop rotation running turns as same as the maximum frequency stop rotation turns after inverter performed stop command with any frequency. For example, the maximum frequency is 60Hz, deceleration time is 1s. If the maximum frequency decelerate stop rotation turns is 5, so the stop rotation turns also is 5 with 40Hz frequency given. The deceleration time of equidistant stop during difference frequency given change as following curve diagram show.

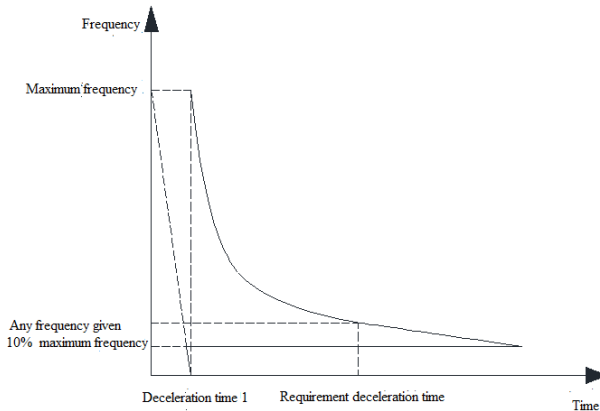

Equidistance deceleration time schematic diagram

Note: 1. This function is disabled when the frequency given less than 10% of maximum frequency, the inverter decelerate based on the deceleration time, it will not performed the equidistant function when the frequency given less than 10% of maximum frequency.

2. The overvoltage and over current suppression occurs when the deceleration time is too short, the actual of deceleration time will be longer, and the equidistant function can't be performed.

LED Thousands digit:

0: Disable

1: Enable

E-16	Frequency reference given by digital keypad	Range: lower limit frequency-upper limit frequency	Default:50.00Hz
------	---	--	-----------------

It uses to set or modify frequency reference when the frequency given channel is set to operator keypad digital given.

Shortcut setting is available as well, changing the frequency reference via up/down arrow key of operator keypad when inverter running or in standby mode.

E-17	V/F curve mode	Range:0-4	Default: 0
E-18	Torque boost	Range:0.0%-25.0%	Default: ※

V/F curve mode: Uses to select V/F curve mode to meet various of load characteristic requirement. AC70 vector control inverter provides 4 kinds of fixed V/F curve and one kind of user defined V/F curve. Constant torque curve is optional for general load and descend torque curve is optional for square torque load such as water pumps and fans load.etc.

0: Constant torque curve

1: Descend torque curve(1.5 power curve)

2: Descend torque curve(1.7 Power curve)

3: Descend torque curve(2.0 Square curve)

4: User define curve :Inverter runs base on user defined V/F curve,[E-18] function is disable. User can program appropriate V/F curves according to the load characteristic, for details please refer to[H-01-H-10].

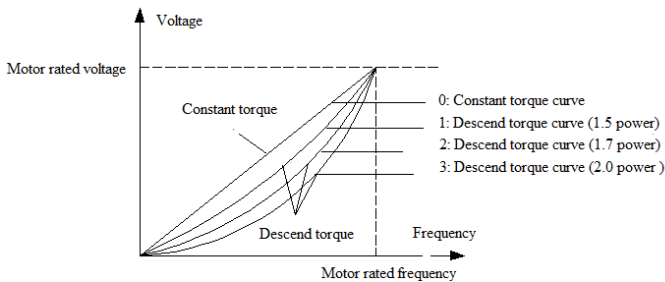

V/F curve diagram

Torque boost: When [E-00] is set to 1(V/F control mode), it is used to enhanced torque output under low frequency running through output voltage boost compensation, when [E-00] is set to 0 (OLV control without PG), the torque boost improvement follows vector control mode,[E-18]setting parameters is disable.

Torque boost value selecting should be according to load inertia. If the boost value is too big, will result in motor overexcited running, and motor over heat easily, even worst, inverter will occurs over current fault protection, or can't start inverter properly.

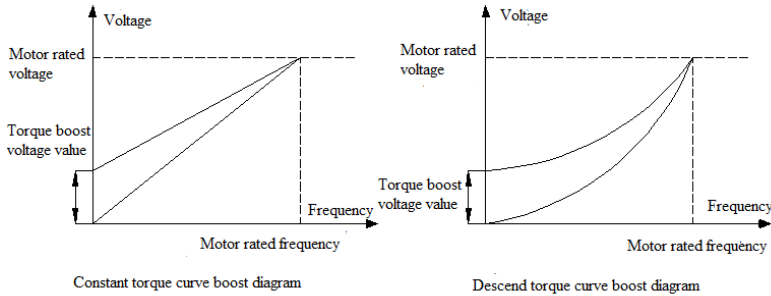

E-19	Filter time	0.01-99.99	Default: ※
------	-------------	------------	------------

This function mainly used to torque boost in OLV control mode. The value setting is smaller, the response of torque boost is faster, the fluctuation of current is bigger, suitable for sudden changing load application; vice versa, the filter time setting is bigger, the response of torque boost is slower, the fluctuation of current is smaller, suitable for constant load application.

E-20	Carrier frequency	Range:0.7KHz-15.0KHz	default: ※
------	-------------------	----------------------	------------

This function mainly used to improve the noise emitting and vibration possibility occurs during inverter operation. The waveform of current will be good when the carrier frequency is bigger, the noise of motor is smaller. It is very suitable for application that silent required, but in this case, but the switching loss of main component is bigger, the temperature rise, efficiency reduces, and output power is smaller. Meanwhile, the radio interference will be bigger, the leakage of capacitor also increases when run in high carrier frequency, that will result in malfunction of residual leakage protector which if have installed, over current will be possibility occurs as well. When frequency carrier is low, it is contrary to the phenomenon mentioned above.

The response of difference motors to carrier frequency is different. The best carrier frequency should be adjust to gain according actual application site. But the carrier frequency should be set smaller for bigger capacity motor.

Veichi reserve the right to restrict biggest carrier frequency.

Carrier frequency	Motor noise	Electrical interference	Switching loss
0.7KHz	big	small	small
8.0KHz	↑	↓	↓
15.0KHz	small	big	big

Below 4KW: When the carrier frequency is 6 KHz, rated current is the maximum output current.

5.5KW-22KW: When the carrier frequency is 3 KHz, rated current is the maximum output current.

30KW-75KW: When the carrier frequency is 2 KHz, rated current is the maximum output current.

Above 93KW: When the carrier frequency is 1.5 KHz, rated current is the maximum output current.

Note: In order to obtain better control characteristics, the ratio of the carrier frequency to maximum frequency of the inverter should not less than 36. If inverter works long-term in low frequency, suggest to reduce the carrier frequency to reduce the impact of the dead zone time.

E-21	Carrier characteristic	Range:0000-1211	Default: 1010
------	------------------------	-----------------	---------------

LED unit Digit: Associate of carrier frequency and output frequency configure.

0: Output frequency associate is disabled.

1: Output frequency associate is enabled.

When the associate of carrier frequency of output frequency is enable, the inverter will adjust the carrier frequency automatically according the output frequency, this function can improve the torque performance in low speed, if combine with torque boost function will make performance better in low speed.

LED tens digit: Associate of carrier frequency and module temperature configure.

0: Module temperature associate is valid.

1: Module temperature associate is invalid.

Inverter will reduce the carrier frequency when the temperature of inverter rise, this function can reduce the switching loss to prevent over heat fault occurs.

LED hundreds digit: PWM mode selection

0: Fixed PWM mode The noise frequency of motor is fixed.

1: Random PWM mode 1 This mode enables the harmonic spectrum of inverter output voltage evenly distributing in a wide frequency range to inhibit the electrical noise and vibration effectively, carrier frequency is 2.0KHz.

2: Random PWM mode 2 As the same as above mention, but carrier frequency is 2.5KHz.

LED thousands digit: Inhibition of shock.

0: Inhibition of shock is disabled.

1: Inhibition of shock is enabled.

E-22	V/F slip compensation	Range:0%-200%	Default: 100%
------	-----------------------	---------------	---------------

This function enables output frequency of inverter automatically regulate with the load of motor changing. This can compensate slip frequency of motor dynamically, it enables the motor maintaining a constant rotation speed to reduce the load changing impacts on the motor speed effectively.

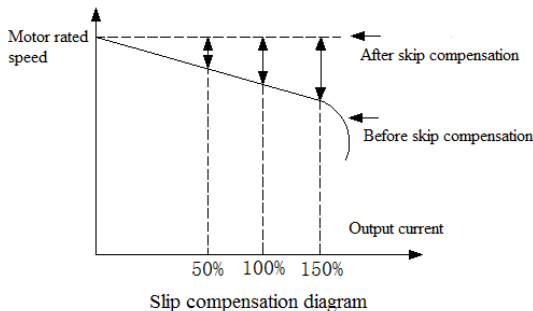

If cooperate with auto torque boost function, the torque performance in low frequency characteristic of inverter will be significantly improved. The value of slip frequency compensation should be set base on motor rated slip, should not set the value of compensation too large.

E-23	Energy saving mode selection	Range: 0000-0011	Default: 1000
------	------------------------------	------------------	---------------

LED unit digit: Auto energy saving selection

0: disable

1: enable

During running process, inverter can automatic calculate the best output voltage to load according to the load condition for energy saving. Energy saving function works by reducing output voltage, enhancing the power factor and improve motor efficiency.

LED tens digit: V/F slip compensation

0: Disable

1: Enable

If only activate the slip compensation function in V/F control mode, this parameters used for selecting slip compensation function.

LED Hundreds digit: Reserve

LED Thousands digit: Over modulation

0: Over modulation allowed

1: Over modulation not allowed

E-24	Voltage auto regulation function	Range:0,1,2,3	Default:2
------	----------------------------------	---------------	-----------

0: Disable

1: Enable in full process

2: Disable only in deceleration

Output voltage auto regulation function that is AVR function. When AVR function disable, the output voltage change vary with input voltage. When the AVR enable, the output voltage will keep in setting value as long as the minimum of fluctuation input voltage bigger than output voltage setting (Motor rated voltage). When the power supply voltage less than rated output voltage, the output voltage will decrease follow with input voltage.

E-25	Jog frequency	Range:0.50Hz-maximum frequency	Default:5.00Hz
E-26	Jog acceleration time	Range:0.1-6500.0s	Default:2.0s
E-27	Jog deceleration time	Range:0.1-6500.0s	Default:2.0s

The jog frequency function has the highest control priority (terminal jog function). It means in any condition, when jog command is valid, the inverter immediately run from the current running frequency to the jog frequency based on jog accelerates/decelerates time. The jog accelerates/decelerates time is defined as same as accelerates/decelerates time, which can be configured by the keyboard, control terminal or job function control command of RS485.

Note: The setting value of the jog running frequency is only limited by the upper limit frequency. Only the priority of job terminal control free from limitation of running control command channel. Other jog command have priority only under the same running control command channel, such as the keypad job command is enabled only in the operator keypad control running.

E-28	Start frequency	Range:0.00-60.00Hz	Default:0.50Hz
E-29	Start frequency holding time	Range time:0.0-20.0s	Default:0.0s

Start frequency: The initial output frequency when inverter starting. The large starting torque is available if the starting frequency is properly set. It can gain high impact when starting instantaneous for some load that has a bigger static friction force in static status. But it will result in a trip if the value is set to big.

Start frequency holding time: It means the inverter keeps running time under starting frequency.

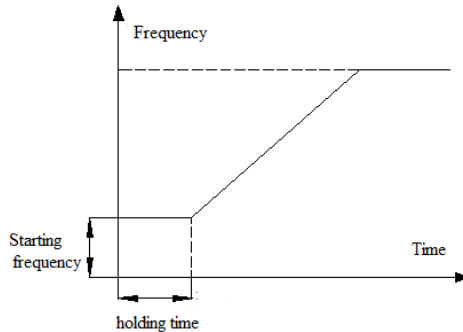

Starting frequency and holding time schematic

Note: The frequency output is 0 when the frequency given less than starting frequency during the acceleration process.

E-30	Starting mode selection	Range:0000-1102	Default:※000
------	-------------------------	-----------------	--------------

LED unit digit: Starting mode selection.

0: Starts from starting frequency Inverter starts with [E-28] starting frequency given and [E-29] starting frequency holding time given. Applicable for application which has big static friction torque, light load inertia, Or suit to work together with machinery that equipped external mechanical braking. That is occasion where the shaft of motor can maintain still before start, but after motor stop.

1: DC braking first, and then start from starting frequency Perform DC braking function first with DC braking voltage [E-35] and DC braking time [E-38] to feed motor a center DC braking energy (Electromagnetic braking), and then starts with starting frequency. Applicable for occasion there are forward or reverse running of small inertia load in stop status.

2: Restart after speed searching Inverter try to detect the speed of a rotating motor shaft that is driven by external forces first and start the motor operation directly from the detected speed to frequency given according acceleration /deceleration time.

Note: During forward/reverse switching process in normal operation, and perform accel/decel process after frequency given modifying, both start from 0.0Hz or stop to 0.0Hz.

LED tens digit: Reserve

LED hundreds digit: Speed search direction

0: Speed search performs only in running direction

1: Bi-speed search performs

LED thousands digit: Speed search mode

0: Software speed search

1: Hardware speed search

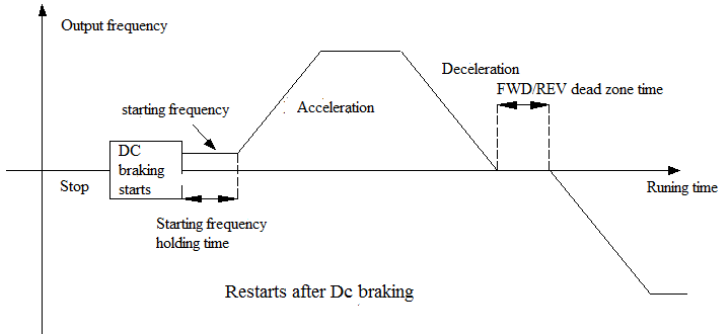

E-31	Power off restart selection	Range:0,1	Default:0
E-32	Power off restart waiting time	Range:0.0-10.0s	Default:0.5s

Power off restart selection:

0: Disable Inverter runs must receive running command given after power off when Power on.

In operator keypad or RS485 communication control mode, the running command will be clear automatically when inverter off.

In the external terminal control mode, the control command of FWD/REV terminal is valid, ignore any parameters setting of [E-31] when power on again after inverter power off.

1: Enable If inverter is running before power off, the inverter starts automatically after waiting time [E-32] setting when power on again.

Note: The restart power off function enable inverter operates automatically after power on again. There fore, there is huge contingency, please be cautious to apply this function ensure safety of person and equipment.

Power off restart waiting time: when the [E-31] setting is valid, inverter starts operation after waiting time [E-32] when power on again.

The principles of this time setting is base on the factors such as the work resume preparation time of equipments which correlate with the frequency inverter after power on again.

E-33	Free stop frequency	Range:0.00-60.00Hz	Default:0.00Hz
------	---------------------	--------------------	----------------

When inverter receives the stop command under deceleration stop mode, it will decelerate to free stop frequency base on the deceleration time, and then lock output, motor stop freely.

Note: This function is valid in stop mode only, disable in Forward/Reverse process.

E-34	Stop mode	Range :0,1	Default:0
------	-----------	------------	-----------

0: Deceleration stop Inverter stop output after decelerate to free stop frequency according to deceleration time and deceleration mode given.

During the decelerate process, when the frequency given less than starting frequency of DC braking stop, the output frequency will jump to zero, and perform DC injection braking, after then stop working if the DC injection braking function is activated.

During the deceleration process, when the DC bus voltage over the [E-53] dynamic braking threshold voltage value, the inverter will output pulse voltage base on dynamic braking ratio [E-54] setting for built in braking unit model (through 15G/18.5P), able to connecting external braking resistor. For no built braking unit machine, can connect external braking unit.

This stop mode mainly used to application which need quick braking required.

1: Free stop After receiving the stop command, frequency inverter will block the output and motor will run to

stop freely. Generally coordinate external mechanical braking to achieve quick stop when this stop mode has been selecting.

E-35	DC braking voltage	Range:0%-150%	Default:50%
E-36	DC braking time when stop	Range:0.0-30.0s	Range:0.0s
E-37	DC braking starting frequency when stop	Range:0.00-60.00Hz	Range:0.00Hz
E-38	DC braking time when start	Range:0.0-10.0s	Range:0.0s

DC braking voltage: The value of voltage which is injected to motor when executing DC braking function. The value of voltage benchmark against the input rated current of inverter.

This function can output torque under zero speed. Generally, it uses to improve the stop accuracy and realize quick stop, but it can't be apply for normal deceleration. The inverter will stop output once DC braking has been performed. If the DC raking current set to big, over current fault occurs easily during stop.

DC braking time when stop: DC braking current lasting time when inverter stops, if the braking time is set to 0, it means the DC braking function is disabled.

DC braking starting frequency when stop It means when inverter decelerated to this frequency, the inverter will stop output, and perform the DC braking function. If the output frequency less than DC braking starting frequency when stop during running process, the inverter will stop output, start DC braking function when receiving the stop command.

The inverter will start DC braking, and the output frequency jump to zero if the frequency given less than DC braking starting frequency when stop during the deceleration process. The DC braking starting frequency when stop should be set smaller when there are no strictly requirement for stop. When the DC braking starting frequency when stop[E-37]parameters setting smaller than free stop frequency [E-33] setting, the inverter will decelerate to free stop frequency, and then stop output execute DC braking.

DC braking time when start: It refer to DC braking voltage lasting time when stop. Only if [E-30] parameters unit digit set to 1, the DC braking function will be enabled. When the braking time set to 0.0s, not perform DC braking function

E-39	Jump frequency 1	Range:0.00-600.0Hz	Default:0.00Hz
E-40	Jump frequency 2	Range:0.00-600.0Hz	Default:0.00Hz
E-41	Jump frequency 3	Range:0.00-600.0Hz	Default:0.00Hz
E-42	Jump frequency range	Range:0.00-5.00Hz	Default:0.00Hz

The Jump frequencies are frequency ranges at which the drive will not operate. The drive can be programmed with three separate Jump frequencies to avoid operating at speeds that cause resonance in driven machinery. If the frequency reference falls within a Jump frequency dead band, the drive will clamp the frequency reference just below the dead band and only accelerate past it when the frequency reference rises above the upper end of the dead band.

Jump frequency range: The frequency up and own jumping bias base on jump frequency

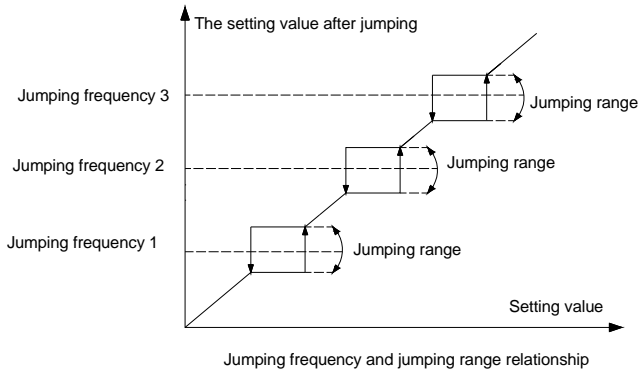

- Note:** 1. The output frequency still will pass the jumping range during acceleration or deceleration. Make sure the parameters don't overlap or inset setting.
 2. Jumping frequency is disabled for jog, multi-step speed and swing frequency.

E-43	Number of auto restart attempts	Range:0-3	Default:0
E-44	Fault auto reset waiting time	Range:0.1-20.0s	Default:1.0s

Number of automatic fault reset: 0: Disable, The auto reset function is disabled, reset only by manual.
 1—3: Enable, 1-3 parameters used for defining the numbers of auto reset. (The maximum time of auto reset is enabled)

The inverter may be trip to stop cause by fluctuation of grid and other accidents reason during operation. Auto reset for overload, over current, system abnormal, overvoltage, under voltage, etc fault occurs is allowable to restart inverter operation ensure system working continuously. Inverter will restart with speed search restart mode during auto reset.

If the auto reset fails to restart during the setting give numbers, the fault protection will be activate, inverter stop output. The maximum of auto reset number setting is 3, the reset numbers will be recount after inverter running normally for 10 minutes, the record times clears automatically. Suggest configure number of auto reset to 1 times will be better.

The fault output terminal can be set disable or enable during fault auto reset process. Refer to [F-30,F-31,F-32]
 Fault auto reset waiting time: Uses for defining the waiting time from fault occurs to reset attempts.

Note: 1. This function only enable for overload, over current, system abnormal, over voltage, under voltage during running, disable for other fault happen.

2. Reset can't make if fault fail to solve, no reset for the temperature of inverter over 70℃

Tips: Users must be cautious to consider the start characteristic of the mechanical devices in crane, lifting application. It should be cautious in using this function for application which can't start with load or the alarm will come out immediately when inverter stop output.

E-45	Machine warm up time	Range:0.0-6500s	Default:0.0s
------	----------------------	-----------------	--------------

Inverter enables command operation after machine warm up time, once power supply switch to inverter. It displays count down in seconds after switch on.

E-46	Running direction selection	Range:0-2	Default:0
------	-----------------------------	-----------	-----------

0: Consistent with the default direction
 The actual direction don't change.

Actual rotation direction is the same with the requirement. The

1: Opposite to the default direction Actual rotation direction is opposite to the requirement. The actual direction will be change.

2: Reverse running forbidden When this parameter is set as prohibition, all the reverse command from Running control command selection (operator keypad, external terminal, RS485 communication, bipolar VS2 and program running) are invalid.
The setting will not be modified after the factory default setting.

Note: 1. When the reverse running forbidden is selected, when the bipolar control receiving the reverse frequency command, the inverter will be operation with 0 speed, the case is the same, inverter will be operate with 0 speed during program running control if there are some certain step speed reverse direction are set.

2. All reverse command will be auto turn to running command, running with forward direction.

E-47	FOR/REV dead zone time	Range:0.0-10.0s	Default:0.0s
------	------------------------	-----------------	--------------

The function defined the transient waiting time from forward to reverse or from reverse to forward during 0Hz. FOR/REV dead zone time special designed for big inertia load application which has mechanical dead zone required.

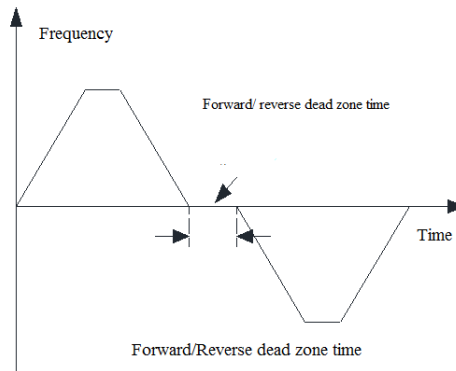

E-48	Cooling fans running selection	Range:0,1,2	Default:※
------	--------------------------------	-------------	-----------

Uses select cooling fan running mode.

0: Fan runs when inverter switch on. Cooling fan stop when under voltage condition, it runs when power supply is stable.

1: Relates with temperature during inverter stop mode, fan runs when inverter running

Fan stop or not is relate to temperature of module during stop mode, fan would operate when the temperature is above 45℃, stop when module temperature lower 40℃. Fan runs immediately when inverter receives a run command.

2: Fan stop during inverter stop mode, relates with temperature during inverter running. Fan stop or not is related to temperature of module during inverter running mode, fan runs when the temperature of module is above 45℃, stops when temperature of module is lower than 40℃. Fan stops always during inverter stop mode.

Note: Use this function correctly enable extend fans working life.

E-49	Inverter protecting mode selection	Range:0000-1111	Default:0※11
------	------------------------------------	-----------------	--------------

LED unit digit: Overvoltage protecting selection during deceleration

0: Disable 1 Enable

During the inverter deceleration, the energy generated by motor feedback to inverter inside due to load inertia effect, which will cause the voltage of inverter over the maximum voltage threshold. The over voltage protecting occurs if without any measure. When overvoltage protection is activated, the inverter deceleration stops (output frequency stop descend) when detecting the DC bus voltage over[E-53]setting, deceleration only allow to continue until the DC bus voltage is lower than the protective value.

Note: It will cause the stop time from deceleration given to stop to be longer if the stall protection is active.

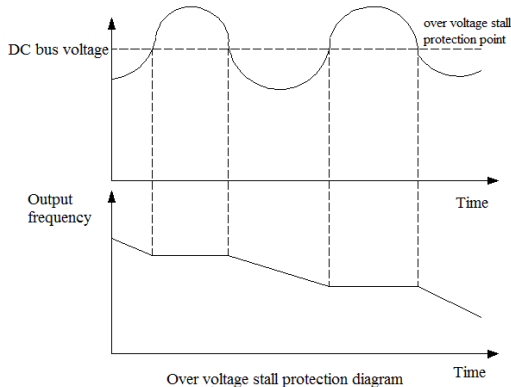

LED ten digit: Output phase missing protection

0: Disable 1: Enable

Used for detecting if output wiring missing when inverter power on, if there are any output phase missing, the Err2 occurs, fault output terminal will be activated.

LED hundred digit: Input phase missing protection

0: Disable 1: Enable

Inverter performs phase missing detecting for 3 phase AC input, if any phase missing, Err1 will occurs, and stop output. Motor will carry out free stop, the fault output terminals will be activate.

LED thousand digit: Inverter overload, over heat protect mode selection.

0: Free stop 1: running with current limit

This parameter will determine the protection mode when overload, over heat occurs.

Free stop means that output of inverter stop immediately, and active 'OL2' and 'OH' fault alarm.

The running with current limit is that inverter running is based on output current limit. If the current over the current limit value, the output frequency will be decreased to reduce the load current. The output terminal [F-30-F-32] can be used to output pre-alarm signal when overload happens.

Current limit value during overvoltage and overheat=rated current ×100%

E-50	Coefficient value of electronic thermal	Range:30%-120%	Default:0%
------	---	----------------	------------

Motor will generate heat seriously in a long time overload running. This parameter is used to set coefficient of thermal relay of motor in inverter. When the rated current of motor is equal to rated current of inverter, the value can be set 100%, when the rated current of motor can't match the rated current of inverter, this parameter value can be set for motor overheat protection properly.

The factory default setting of overload capacity of inverter as follows:

G type: 150%× rated current for 1 minute.

F type: 120%× rated current for 1 minute.

The parameters setting value can follow below formula:

Coefficient value of electronic thermal=rated current/ rated output current of inverter

Note: This function would fail when one inverter drives multiple motors in parallel. Please install the thermal relay before motor input to protect motor effectively

E-51	Stall protecting current limit value	Range:100%-250%	Default:160G/120P
------	--------------------------------------	-----------------	-------------------

It is used to define the ratio of stall protection current limit to rated current motor.

G type default setting: 160%

P type default setting: 120%

Stalling protecting current limit function means that inverter will limit load current automatically with in time monitoring during the acceleration, make it lower than the limit setting, (Stops acceleration or lower the output frequency to achieve the value of output current controlling), to protect big current occurs result in fault alarm trip. This function is suitable for application where has big inertia or load fluctuates severe particularly.

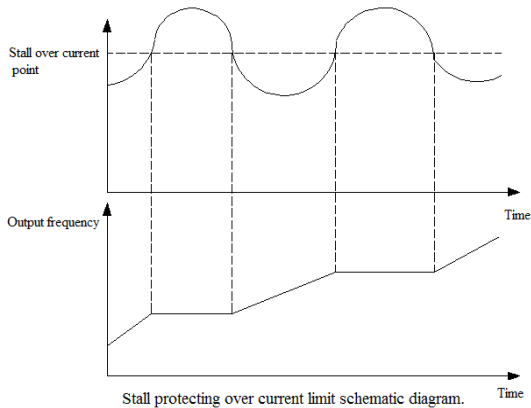

This parameters datum line is rated current of inverter. It will extend acceleration time longer. It means the current limit function is activated if the frequency can't accelerate to set value or frequency given, but fluctuates in the fixed frequency range. Please reduce the load or adjust the some relevant parameters.

E-52	Stall protecting DC bus voltage threshold	Range:105%-160%	Default:138%
------	---	-----------------	--------------

This parameter is defined as the ratio of the stall protection DC bus voltage threshold to rated DC bus voltage of frequency inverter.

Rated inverter DC bus voltage value=Rated input voltage of inverter×1.414

It defines the over overvoltage stall protecting threshold during the deceleration time. While the DC side pumping voltage cause by decelerating exceeds this parameter settings, the inverter will auto-prolong the deceleration time.

E-53	Dynamic braking and decelerating over voltage suppression threshold voltage	Range: 105%-160%	Default: 130%
E-54	Ratio of dynamic braking	Range: 0%-100%	Default: 100%

Decelerating overvoltage suppression threshold voltage: This value is enabled while [E-49] set to 1

Dynamic braking over voltage threshold voltage: The dynamic braking will be activate when the DC bus voltage rise over than rated voltage of inverter [E-53] setting. The voltage of dynamic braking stop is lower 20V than [E-53] setting, please make this setting cautiously.

This function is valid for inverter which built in braking accessory only, AC70 series 22G/30 and 30G/37 both inverters have braking accessory option, standard built in braking accessory through 15G/18P inverter. Please

select braking unit or braking accessory if need for other model.

Ratio of dynamic braking: This parameter defines the average of voltage which applied on the braking resistor when braking unit effecting. The voltage applied on the braking resistor is PWM wave, the duty cycle is equal to ratio of dynamic braking. The ratio bigger, energy release faster, the braking effects better, and the same time the more energy consumes on the braking resistor. Selecting the braking resistor value, power and braking effects should take comprehensive consideration to set this parameter.

E-55	DC bus under voltage protecting value	Range:60%-90%	Default: 65%
------	---------------------------------------	---------------	--------------

This parameter defines the DC bus side lower limiter voltage while inverter in normal working condition. It allow to set under voltage protecting levels lower to ensure inverter normal working for power grid lower situation.

Note: The output torque will be reduced when the power grid voltage is low. For the constant power load and constant torque load application, the too low power grid voltage will increase input and output current, which will reduce the inverter ruing reliability.

E-56-E-58	Reserve		
-----------	---------	--	--

E-59	Rotation speed display scale factor	Range:0.1-2000.0 %	Default:100.0%
------	-------------------------------------	--------------------	----------------

It uses to set the display factor of keypad monitor, 100.0% correspond with motor rated speed. The upper limit machine speed is 65000 RPM.

E-60	Ratio of inverter output voltage	Range:50%-110%	Default:100%
------	----------------------------------	----------------	--------------

Ratio of output voltage to rated voltage of inverter. This function uses to coordinate the output voltage to meet various types of V/F characteristic requirement.

Output voltage of inverter = rated voltage of inverter ×Ratio of inverter output voltage

E-61	G/P type setting	Range:0 , 1	Default:0
------	------------------	-------------	-----------

When reset the factory setting, this parameter setting values will not be changed.

0:G model, it is suitable for constant torque load.

1:P model, it is suitable for variable torque (such as fan, water pump load) .

The AC70 series frequency inverter adopts G/P in one mode. The power of the motor adaptability used in the constant torque load (G model) is lower one grade than that used in fan, water pump load (P model)

E-62	Speed search stability keeping time	Range:0.20-10.00s	Default:0.600s
------	-------------------------------------	-------------------	----------------

This parameter defines the time of inverter try to run stably when inverter detected the frequency point during speed search process. Inverter accelerates to frequency set point with acceleration time given.

For the big inertia load, extend the speed search stability keeping time can reduce the instantaneous impact current of speed search start.

E-63	Parameters change protection	Range:0-2	default: 0
------	------------------------------	-----------	------------

0:All the parameters changing allowed Except for the parameters only for inquiry, any other parameters can be changed (Note: Some parameters only can be changed in the stop state, some parameters can not be changed in any condition) .

1: Only keyboard digital given parameter changing allowed Except for the keyboard digital given frequency and keyboard number PID given quantitative parameter, any other parameter don't allow changing.

2: All the parameters prohibit changing All the parameters of frequency inverter unchangeable; When users need to change the parameter, They have to change this parameter as 0 or 1.

E-64	Parameter initialization	Range:0-4	Default: 0
------	--------------------------	-----------	------------

0: Null

1: Restores to factory default setting value Function parameters will restore to factory default setting after performed parameters initialization.

2: Clear fault record All historical fault record will be cleared.

3. Transfer parameters of inverter to keypad and save. Copy parameters saved of inverter to keypad and preserve.

4. Transfer parameters saved of keypad to inverter Download parameters of keypad to inverter.

Note:

1. **During the inverter running state, Parameters saved of keypad can't transfer to inverter when in fault state or no parameters save in keypad.**
2. **If keypad is pulled out during transferring parameters of inverter to keypad and saving process, this function will be fail. It need redo parameters copy.**
3. **If the first part of parameters has been modified, the latter part hasn't been changed when keypad is pulled out during transferring parameters copy of keypad to inverter. This function need redo again.**
4. **The current running state of inverter will not be stored in parameters of inverter transfer to keypad operation. All keypad are null and invalid when transferring the parameters saved of keypad to inverter.**
5. **When E.CPE (parameters copy abnormal) appears on the keypad in parameters copy operation, the copy is stopped at this moment. It need redo copy again with pressing PRG button return to monitor state.**
6. **The parameter saved of keypad can't be transfer to inverter if the version is incompatible with E.EDI display.**

Note: The current setting value of [E-46, E-61]will not be affected when performing the factory default restoring. The setting value 3 or 4 of [E-64] parameters will be set to 0 automatically after parameters copy.

E-65	Factory password	Range:0-9999	Default: 0
------	------------------	--------------	------------

Manufacturer inquiry parameters.

E-66	Information check	LED unit digit: 0: Null operation 1: State monitoring inquiry 2: Fault information inquiry LED ten digit: LCD display language 0:Chinese 1:English	Default: 0
------	-------------------	--	------------

LED unit digit:

0: Null operation

1: State monitoring inquiry

2: Fault information inquiry

0: Null operation

1: State monitoring inquiry Selects this function to enter monitoring menu (group C parameters), and inquire each state parameters of the frequency inverter. In the monitoring state, with long pressing (1 second) PRG key and enter directly the state of the group C parameters that is status of state monitoring inquiry.

Monitoring code	Content	Unit	Communication cod
C-01	Frequency reference given	0.01Hz	C01H
C-02	Output frequency	0.01Hz	C02H
C-03	Output current	0.1A	C03H
C-04	Input voltage	V	C04H
C-05	Output voltage	V	C05H
C-06	Machine speed	RPM	C06H
C-07	PID given value	%	C07H
C-08	PID feedback value	%	C08H
C-09	Module temperature	°C	C09H
C-10	Accumulative running time (the total timing of output frequency which large than 0Hz, 0Hz running and stop status timing is disabled)	Hour	C0AH
C-11	Accumulative running timing after last power on	Minute	C0BH
C-12	Output current percentage	%	C0CH
C-13	Multi-Step operation remainder time percentage	%	C0DH
C-14	Input terminals OFF/ON status	Refer to below table	C0EH
C-15	Output terminals OFF/ON status	Refer to below table	C0FH
C-16	Terminal VS1 input value	0.1V	C10H
C-17	Terminal AS input value	0.1mA	C11H
C-18	Terminal VS2 input value	0.1V	C12H
C-19	Terminal pulse input value	※	C13H
C-20	Counter record	※	C14H
C-21	DC bus voltage	V	C15H
C-22	Analog output A01	※	C16H
C-23	Frequency/voltage/current outputA02	※	C17H
C-24	Reserve	--	C18H
C-25	Inverter rated power	kW	C19H
C-26	Inverter rated voltage	V	C1AH
C-27	Inverter rated current	0.1A	C1BH
C-28	Software version	※	C1CH

Input terminal OFF/ON state schematic diagram

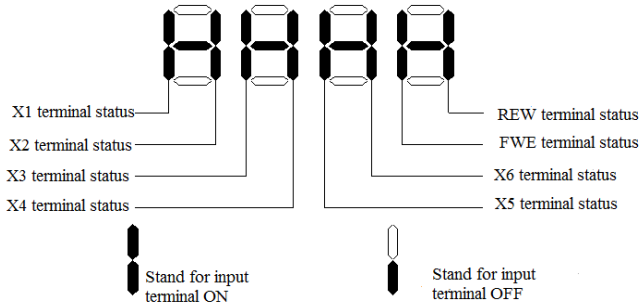

Input terminal OFF/ON status diagram

Output terminal OFF/ON status schematic diagram

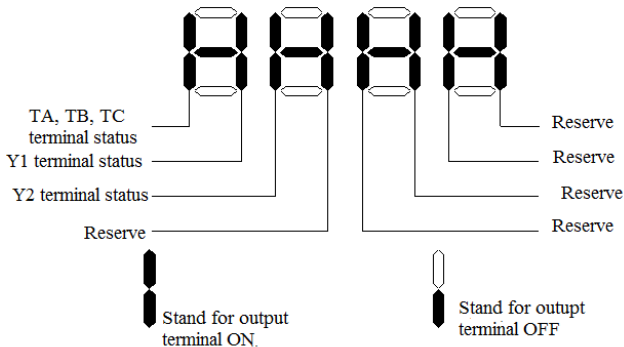

Output terminal ON/OFF status diagram

2: Fault information inquiry

After inquiry setting, digital LED display below table information. Recycling shows is available via press up and down keys.

Serial number	Definition	Remark	Communication code
Er.01	The latest fault information	Refer to fault information code to get more in detail	E01H
Er.02	The cumulative running time before the latest fault	Units: hour	E02H
Er.03	Output frequency while the latest fault	Units: Hz	E03H
Er.04	DC bus voltage while the latest fault	Units: V	E04H
Er.05	Output current while the latest fault	Units: A	E05H
Er.06	Output voltage while the latest fault	Units: V	E06H
Er.07	Module temperature while the latest fault	Units: °C	E07H

Er.08	Running direction while the latest fault	0.Forward 1.reverse	E08H
Er.09	Running status while the latest fault	0. Stop 1. Constant running 2. Acceleration 3. Deceleration	E09H
Er.10	Protection status while the latest fault	0. Normal 1. Only voltage amplitude limit 2. Only current amplitude limit 3. Both voltage and current amplitude limit	E0AH
Er.11	Input terminal status while the latest fault	See above table	E0BH
Er.12	Output terminal status while the latest fault	See above table	E0CH
Er.13	The latest first fault information		E0DH
Er.14	The latest second fault information		E0EH
Er.15	The latest third fault Information		E0FH

Fault information code table:

Serial number	Keyboard display content	Fault information
0	----	No fault
1	L.U.1	The power supply is too low in stop (Don't record this fault in fault logging)
2	L.U.2	The power supply is too low in running (Don't record this fault in fault logging)
3	o.U.1	Overvoltage in acceleration
4	o.U.2	Overvoltage in deceleration
5	o.U.3	Overvoltage in constant speed
6	o.U.4	Over voltage in stop
7	o.C.1	Over current in acceleration
8	o.C.2	Over current in deceleration
9	o.C.3	Over current Constant speed
10	o.L.1	Motor overload
11	o.L.2	Inverter overload
12	Sc	System fault
13	o.H.	Inverter interior overheat
14	Sen	Feedback sensor fault (Don't record this fault in fault logging)
15	Err1	Phase missing in input side
16	Err2	Phase missing in output side
17	Err3	Current detected fault (Don't record this fault in fault logging)
18	Err4	Inverter external fault
19	Err5	Swing frequency running parameter setting error
20	Err6	Keypad communication fault (Don't record this fault in fault logging)
21	LIFE	Reserved (Seek to the technical support, don't record this fault in fault logging)

22	93SE	Storage fault (Don't record this fault in fault logging)
23	E.TE1	Stationary auto tuning fault (Don't record this fault in fault logging)
24	E.TE2	Rational auto turning fault (Don't record this fault in fault logging)
25	Reserve	
26	E.CE	RS485 communication fault
27	E.PAn	Communication fault of keypad during power on (Don't record this fault in fault logging)
28	E.CPE	Parameters copy fault (Don't record this fault in fault logging)

LED ten digit: LCD display language

0:Chinese

1:English

E-67	Interference suppression selection	Range:0000-1221	Default:0001
------	------------------------------------	-----------------	--------------

LED unit digit: Overvoltage interference suppression

0: Disable

1: Enable When this function is activated, the inverter will take intellectualized judge for over voltage fault, only respond for true fault signal, suppresses the interference. It may causes alarm delay, should be used with caution

LED ten digit: SC interference suppression

0: Disable

1: SC interference suppression 1 When this function is activated, the inverter will take intellectualized judge for SC fault, only respond for true fault signal, suppresses the interference. It may causes alarm delay, should be used with caution.

2: SC interference suppression 2 It has strong SC interference suppression ability compare to SC interference suppression 1. It may causes alarm delay, should be used with caution.

LED hundred digit: over current interference suppression

0: Disable

1: Over current interference suppression 1 When this function is activated, the inverter will take intellectualized judge for over current fault, only respond for true fault signal, suppresses the interference. It may causes alarm delay, should be used with caution.

2: Over current interference suppression 2 It has strong over current interference suppression ability compare to over current interference suppression 1. It may causes alarm delay, should be used with caution.

LED thousand digit: over current in deceleration suppression

0: Disable

1: Enable When this function is activated, the current limit function will be executed if over current occurs during the deceleration.

2: Enable frequency reduce for protecting over current. Selects this value for 2, if the output current achieve to [E-52] current threshold given setting, the inverter will decelerate according to the [F-23] deceleration time given setting, when after the output current lower to [E-52] current threshold, inverter will accelerate to frequency reference given according to [F-22] acceleration time given setting.

8.2 External Terminal Parameters

F-01	Input signal selection 1(X1)	Range:0-28	Default:27
F-02	Input signal selection2(X2)	Range:0-28	Default:28
F-03	Input signal selection 3(X3)	Range:0-28	Default:1
F-04	Input signal selection 4(X4)	Range:0-28	Default:2
F-05	Input signal selection 5 (X5)	Range:0-28	Default:3
F-06	Input signal selection 6(X6)	Range:0-28	Default:4

Defines the control digital terminal function, it is enabled when short connecting ON with COM terminal.

Setting value	Definition	Function description
0	Invalid(check optional is available)	This port is free
1	Forward jog operation	Jog command input port. Terminal jog commands have the highest priority.
2	Reverse jog operation	
3	Free stop	Free stop command input port
4	Fault reset	External reset command input port when fault
5	Multi steps speed control 1	The multi steps speed commands input port, up to 8 steps speed control is available; The multi steps speed commands has priority only next to the jog command;
6	Multi steps speed control 2	
7	Multi steps speed control 3	
8	Multi steps speed control 4	
9	UP/Down running frequency increasing UP	Realize the ascend, descend control function, enable when [E-02]or[E-03]is set as"7" ;
10	UP/Down running frequency decreasing DW	
11	Three wire operation control D (X)	Defines as D(X) in three line operation control, refer to parameters [F-08].
12	PID control cancel	PID control is canceled when PID control operating, take PID given signal as frequency reference given, inverter runs at this speed
13	External fault alarm	Input port of external fault signal
14	Acceleration/deceleration time selection terminal 1	Refer to the below fig.
15	Acceleration/deceleration time selection terminal 2	
16	Frequency main channel selection terminal 1	When [E-02]is selected for"12",Frequency given main channel control by terminal ; Four digital terminals will be combined to 0-11 controlling channels, separately corresponding to the[E-02]
17	Frequency main channel selection terminal 2	

18	Frequency main channel selection terminal 3	0-11 frequency input channels
19	Frequency main channel selection terminal 4	
20	Program running pause	During the program running, this signal enable program running to pause. Output frequency will be 0 if this command is activated, continue to run base on running status before pause if pause signal disappears.
21	Program restart	During the program running, if this signal is valid, it enables the program running to restart, starts to run from first stage;
22	Timer trigger terminal	Start timer to start timing, refer to in detail [F-38] .
23	Timer reset terminal	Clear the records of the timer
24	Counter reset terminal	Clear the records of the counter
25	Counter clock input terminal	Refer to [F-39, F-40]
26	Only terminal control channel is enabled selection	Only terminal control channel is enabled, keypad and Rs485 command channel is invalid.
27	Forward running	Refer to forward running description in detail.
28	Reverse running	Refer to forward running description in detail.

Acceleration/deceleration time selection reference list.

Terminal 2	Terminal 1	Acceleration/deceleration time selection
OFF	OFF	Acceleration time 1 and deceleration time 1
OFF	ON	Acceleration time 1 and deceleration time 2
ON	OFF	Acceleration time 1 and deceleration time 3
ON	ON	Acceleration time 1 and deceleration time 4

Short connect with (COM) is "ON", disconnection is "OFF"

Forward running description: As the running command given by terminal, and if **[F-08]** set as standard operation control, when this terminal is valid, inverter runs in forward direction, refer to **[F-08]** parameters for other control mode function.

Reverse running description: As the running command given by terminal, and if **[F-08]** set as standard operation control, when this terminal is valid, inverter runs in reverse direction, refer to **[F-08]** parameters for other control mode function.

F-07	Input signal respond mode selection	Range:0000-1121	Default:0001
------	-------------------------------------	-----------------	--------------

LED unit digit: Free stop terminal recover mode

0: Recover to original command with speed search function

1: Don't recover to original command

2: Recover to original command without speed search function, No speed search of this function need to set unit digit of **[E-30]** for 2 together.

LED ten digit: UP and DW terminal control starting frequency setting

0: Runs with UP/DW terminal adjusting without save the frequency record after power loss.

1: UP/DW terminal adjusting, save the frequency record after power off stop. Inverter will run to last stop moment frequency and then perform UP/DW adjusting. (Refer to [F-70] to Check or modify last stop moment frequency).

2: Runs to preset frequency [F-70] first, and then execute UP/DW adjusting.

LED hundred digit: STOP/RESE of keypad effective range selection.

0: STOP/RESE key valid only when under keypad control

1: STOP/RESE key valid under any run command source. This function is suitable for using emergency stop in NOT keypad control mode.

Note: If selects to STOP/RESE key valid under any run command source, pressing the stop key of keypad, inverter will be located in stop lock status when in terminal control or RS485 control mode. If want to using terminal or Rs485 running control channel command to restart inverter running, you must sent stop command by given channel to unlock stop status first. Frequency inverter enable to restart after stop status unlocking.

LED thousand digit: Terminal running mode selection after fault reset

0: Start inverter running directly after power on in terminal control mode

1: Stop first and then start in terminal control mode

Note: When fault occurs of inverter, reset valid signal can be sent by the all 3 running control command. If the frequency inverter adopts the terminal control mode, after frequency inverter reset by receiving terminal or the other two channels' reset signal, this parameter can be used to select whether to carry on the terminal running command.

F-08	Terminal running control mode	Range:0000-0005	Default: 0000
------	-------------------------------	-----------------	---------------

LED unit digit: Terminal control mode selection

0: Standard running control mode Running and direction are bonded together. This 2 wire control mode is most commonly using. Uses X1 (forward running) and X2 (reverse running) terminals command to determine the Forward /Reverse running of motor. Refer to below fig.

K1	K2	running command
0	0	Stop
1	0	Forward
0	1	Reverse
1	1	Stop

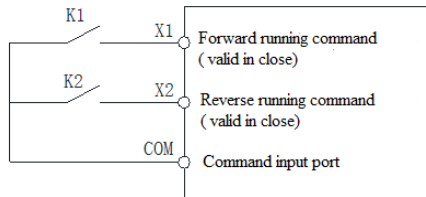

1: Two wire running control mode Running and direction are separated. Uses the forward running terminal X1 (forward running) to determine running control, reverse running terminal X2 (reverse running) to determine direction control. Refer to below fig.

K1	K2	running command
0	0	Stop
1	0	Forward
1	1	Reverse
0	1	Stop

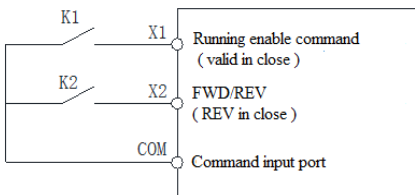

2. Three wire control mode 1 Three wire control terminal (Xi) is used for stop running terminal. Running command determined by forward running terminal X1 (forward running), direction determined by reverse running terminal X2 (reverse running). 3 wire running control terminal Xi is used for enable input.

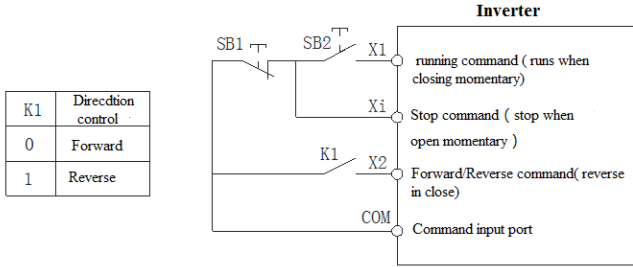

Tip: In 3 wire control mode 1 Fig, SB1 is a normal close stop button, SB2 is a normal open button. K1 is a direction selection switch; Xi is multi-function terminal (X1-X6) which have been programmed for 3 wire running control terminal.

3: 3 wire control mode 2 In this mode, 3 wire running control terminal (Xi) is used for stop running terminal, the running command is generated by forward running terminal X1(forward running) or reverse running terminal X2(reverse running), also control the direction at the same time.

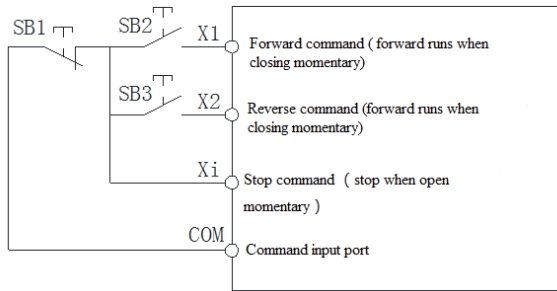

Tip: In 3 wire control mode 2 Fig, SB1 is a normal close button, SB2 and SB3 both are normal open button and pulse edge is valid, uses for inverter direction control.

4: 3 wire control mode 3 3wire running control terminal (X1) is used for running command given terminal, running in connecting ON, stop in disconnecting OFF. Rotation direction is determined by forward running terminal X1 (forward running) or reverse running terminal X2(reverse running). Every starting running with last time direction memorized

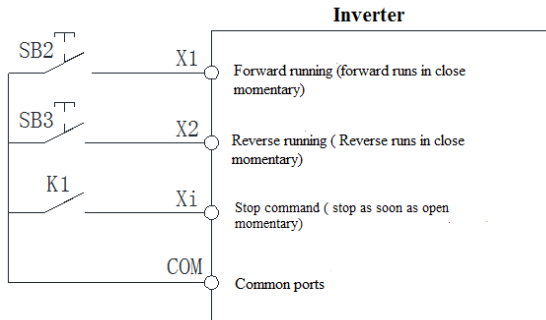

Tip: 1. SB2 and SB3 both are normal open button, and enable by pulse edge.

2. If need start motor in forward direction, press the K1 first, and press SB2 immediately.

3. If need start motor in reverse direction, press the K1 first, and press SB3 immediately.

5: 3 wire control mode 4 3 wire running control terminal (X1) uses for stop command terminal, running command is determined by forward running terminal X1 (forward running), direction is controlled by reverse running terminal X2 (reverse running), and direction will change after every Xi is activated. Every starts running based on last direction memorized. 3 wire running control terminal X1 for effective input.

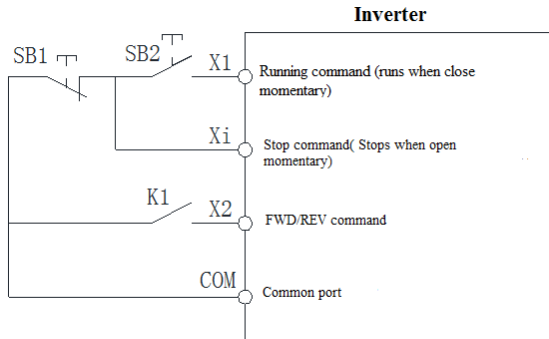

Tip: SB1 is a normal stop button, SB2 is a normal open button. K1 used for running direction selection button. Xi is multi-function terminal (X1-X6) which have been programmed for 3 wire running control terminal.

LED ten digit: Reserve

LED hundred digit: Reserve

LED thousand: Reserve

F-09	1 step speed setting 1X	Rang:0.00Hz-upper limit frequency	Default: 30.00Hz
F-10	2 step speed setting 2X	Rang:0.00Hz-upper limit frequency	Default:25.00Hz
F-11	3 step speed setting 3X	Rang:0.00Hz-upper limit frequency	Default: 40.00Hz
F-12	4 step speed setting 4X	Rang:0.00Hz-upper limit frequency	Default: 50.00Hz
F-13	5 step speed setting 5X	Rang:0.00Hz-upper limit frequency	Default: 50.00Hz
F-14	6 step speed setting 6X	Rang:0.00Hz-upper limit frequency	Default: 40.00Hz
F-15	7 step speed setting 7X	Rang:0.00Hz-upper limit frequency	Default: 25.00Hz
F-16	8 step speed setting 8X	Rang:0.00Hz-upper limit frequency	Default: 10.00Hz

Uses for setting program running and multi-step speed running frequency separately.

Multi-step speed control has the priority only next to the jog function. If users choose the multi-step speed running mode, they need to set four multi-function input terminals as multi-step control terminal. ON/OFF between the four terminals and (COM) determine the running speed steps. Its running and direction is controlled by the running signal and direction given by the running control command channel [E-01]. And its acceleration, deceleration time is controlled by the acceleration, deceleration time 1 in default. Or specifies the particular acceleration, deceleration time by [F-01]-[F-06] parameters setting.

Swing frequency control need to configure the [F-09] and [F-10], refer to [H-51]parameters for the requirement setting of [F-09] and [F-10]. Inverter will appear fault alarm "Err5" if wrong setting.

Tip 1. Multiple step speed running don't limited by lower limit frequency, but subject to upper limit frequency.

2. Output of program running is subject to limit by upper and lower limit frequency. Inverter will run with lower limit frequency when the frequency given less than lower limit frequency.

Short connecting with COM stands for ON, disconnecting for OFF

Multi-step control terminal 4	Multi-step control terminal 3	Multi-step control terminal 2	Multi-step control terminal 1	Terminal Step Speed
OFF	OFF	OFF	ON	1X
OFF	OFF	ON	OFF	2X
OFF	OFF	ON	ON	3X
OFF	ON	OFF	OFF	4X
OFF	ON	OFF	ON	5X
OFF	ON	ON	OFF	6X
OFF	ON	ON	ON	7X
ON	OFF	OFF	OFF	8X

F-17-F-18	Reverse
-----------	---------

F-19	Speed search tracking speed	Range:0.1-10.0%	Default: 0.2%
F-20	Voltage stores time	Range:0.10-10.00s	Default: 0.60s
F-21	Speed search respond current threshold value	Range:10-200%	Default: 120%

This group parameters will be use in software speed search mode. Software speed search will detect out the motor speed from current, and stores voltage based on [F-20] voltage stores time under upper limit frequency or given frequency. When the output current bigger than [F-21], inverter will lower the output frequency with [F-19] speed search speed tracking. When the current lower than [F-21] and maintain [E-62] time setting, it judges the output frequency and motor speed is synchronous, will accelerate or decelerate to frequency reference given. Software speed search processing schematic as following tale:

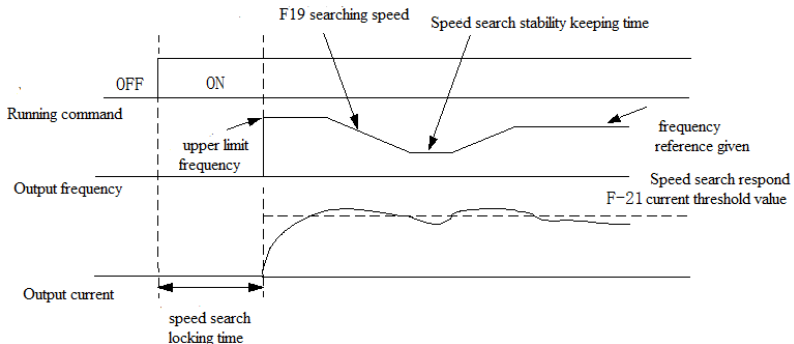

Note: The motor may decelerate suddenly when drive a light load.

F-22	Frequency reducing acceleration time	Range:0.1-6500.0s	Default: 2.0s
F-23	Frequency reducing deceleration time	Range:0.1-6500.0s	Default: 0.3s

Frequency reducing accel/dec. time: When parameters[E-67] is set to "2****", inverter will reduce frequency

to protect over current occurs when load fluctuates suddenly. This parameter is used to define the acceleration /deceleration time of frequency reducing.

F-24	Acceleration time 2	Range: 0.1-6500.0s	Default: ※
F-25	Deceleration time 2	Range: 0.1-6500.0s	Default: ※
F-26	Acceleration time 3	Range: 0.1-6500.0s	Default: ※
F-27	Deceleration time 3	Range: 0.1-6500.0s	Default: ※
F-28	Acceleration time 4	Range: 0.1-6500.0s	Default: ※
F-29	Deceleration time 4	Range: 0.1-6500.0s	Default: ※

Acceleration time 2/3/4: When the [E-15] LED ten digit is set to 0, this refers to requirement time of accelerate from 0.00Hz to maximum frequency [E-09]. When the [E-15] LED ten digit is set to 1, this refers to requirement time of accelerate from 0.00Hz to motor rated frequency [H-53]. Refers to [E-15] parameters in detail.

Deceleration time 2/3/4: When the [E-15] LED ten digit is set to 0, this refers to requirement time of decelerates from maximum frequency [E-09] to 0.00Hz. When the [E-15] LED ten digit is set to 1, this refers to the requirement time of decelerates from motor rated frequency [H-53] to 0.00Hz. Refers to [E-15] parameters in detail.

Note: 1. It need to program the acceleration, deceleration time 2 during in UP/DW control ruing, refers to [E-02] in detail.

2. It need to program the acceleration, deceleration time 2 during swing frequency control, refers to [H-65] parameters in detail.

3. In program running mode, defines acceleration/deceleration time from 2 to 4 separately. Definition of the acceleration /deceleration time is the same as Accel./Decel. time 1. The Accel./Decel time are configured by [H-35]-[H-49] parameters.

4. Acceleration/deceleration time of multi-step speed are programmed by [F-01]-[F-06]. The default setting is acceleration/ deceleration time 1.

F-30	Relay output terminal (TA,TB,TC)	Range: 0-22	Default: 1
F-31	Output terminal Y1	Range: 0-22	Default: 4
F-32	Output terminal Y2	Range: 0-22	Default: 7

Setting Value	Definition	Function description
0	Zero frequency (standby state)	Output signal when inverter is running and output frequency is 0 Hz,
1	Fault alarm 1	Output signal when fault alarms happening (including OU, OL, SC, OC, OH, LUS, etc), enable output including fault reset auto period
2	Fault alarm 2	Output signal when fault alarms happening (including OU,OL,SC,OC, OH,LUS, etc), disable during fault auto reset period.
3	Frequency arriving detection	When the output frequency is approaching or arriving to the frequency given bias range, outputs valid signal, otherwise output invalid signal. The bias range is determined by the parameter [F-33].
4	Frequency level detection	When the output frequency over than frequency detecting level [F-34] setting, output valid signal after [F-35] relay time setting. When the output frequency lower than frequency detecting level, output a invalid signal after the same [F-35] relay time setting.

5	running statuses	Output signal when inverter in running status.
6	Reverse running	Output signal when inverter runs in reverse direction
7	Under voltage of inverter	Output signal when inverter shows "LU1/2" alarms due to under voltage
8	Overload pre-alarm	Outputs signal, when the output current of frequency inverter reach to [F-36] and [F-37] setting values, it outputs signal.
9	Output frequency reach upper limit frequency	Outputs signal, when the output frequency reach to upper limit frequency.
10	Output frequency reach lower limit frequency	Outputs signal, when the output frequency reach to lower limit frequency.
11	External fault stop	Outputs valid signal when inverter stop resulted in by external fault alarm signal input.
12	Timer times up	When it is time up to the given setting time of timer of inverter's inside. Outputs a 1 second width valid pulse signal.
13	Counter reach maximum values	When counter reach to maximum value, output terminal outputs a valid signal with width equal to external clock period.
14	Counter reach setting values	When the counter reach the setting values, output terminal outputs valid signal, and continue to count until achieve to maximum value. This valid signal will cancel when counter reset which cause by counted up to maximum value.
15	PID feedback upper limit alarm	Outputs signal when detecting PID feedback value reach to upper limit alarm value [H-26] .
16	PID feedback lower limit alarm	Outputs signal when detecting PID feedback value reach to lower limit alarm value [H-27] .
17	Sensor broken	When the feedback less then [H-28] setting value, the sensor is considered to broken during the detecting signal in PID control. It will output signal.
18	Program running cycle completed	When program finishes the cycle running, it output 500ms low level signal.
19	Program running step completed	When program finishes the step running, it outputs 500ms low level signal.
20	Dynamic braking processing	Outputs signal when perform dynamic braking.
21	Output terminal control by external	When selects this function, output terminal status can be changed by [H-79] setting. [H-79] value configured by RS485 communication, the binary 0,1, 2 are corresponding to relay output terminal, Y1, and Y2 terminal.
22	22. Fault alarm 1. (Including fault auto reset period, including fault-LU1)	Output signal when fault alarms happening (including OU, OL, SC, OC, OH, LUS, etc), enable output including fault reset auto period

Tip: The output terminal of relay TA-TC close, TB-TC open are considered to valid signal, low level output terminal Y1, Y2 combine with (+24) terminal output 24V power supply considered valid signal.

F-33	Frequency arriving detect bias	Range: 0.00-50.00Hz	Default: 1.00 Hz
F-34	Output frequency level detection	Range: 0.00-600.0Hz	Default:30.00 Hz
F-35	Output frequency level detecting relay time	Range: 0.0-20.0s	Default: 0.0s

When output frequency approaches or close to frequency reference given value, output terminal outputs signal. [F-33] function uses to adjust the bias of the detection amplitude.

Output frequency level detection: Uses it to program the frequency detection level, when the output frequency high [F-34] setting value, output terminal will output signal after [F-35] setting relay time. When the output frequency low to than [F-34] setting value, output terminal will stop output signal after [F-35] setting relay time.

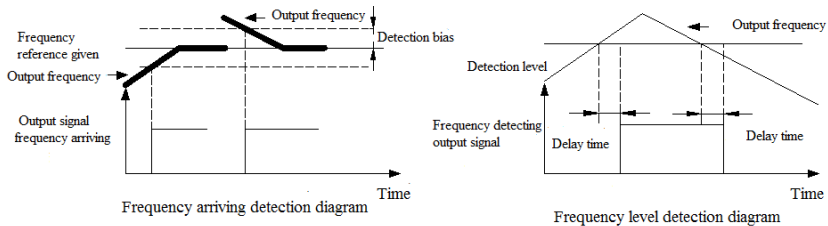

F-36	Overload pre-alarm level	Range: 50%-200%	Default: 150%
F-37	Overload pre-alarm delay time	Range: 0.0-20.0s	Range: 1.0s

If the output current continues to be over the setting level of the parameter [F-36], after the delay time [F-37], the output terminal outputs valid signal. In the same way, when the output current is lower than the setting level of [F-36], after the delay time [F-37], the output terminal outputs invalid signal.

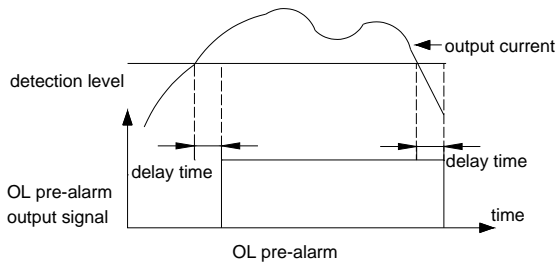

F-38	Timer setting value	Range: 1-65000s	Default: 1s
------	---------------------	-----------------	-------------

This parameter is used to timing for the frequency inverter. The timer start-up is activated by the external trigger terminal of the timer (trigger terminal is selected by [F-01-F06]). Timing from receiving the external trigger signal, while reaching the timed time, it outputs a width is 1 second pulse signal by the corresponding output terminal. If the external trigger signal always locate trigger condition, the corresponding terminal outputs a pulse signal every [F-38] setting time.

F-39	Counter maximum value	Range: 1-65000	Default: 1000
F-40	Counter setting value	Range: 1-counter maximum value	Default: 100

This parameter stipulate the counting action of the interior counter, clock terminal of the counter is selected by the parameter **[F-01-F-06]**.

When the count value to the exterior clock reaches **[F-39]** setting value, in the corresponding output terminal, it outputs a valid signal with a width equal to exterior clock cycle. The output signal stops while the next count signal is input.

When the count value to the exterior clock reaches **[F-40]** setting value, in the corresponding output terminal, it outputs a valid signal. While it reached **[F-39]** and the counter clear to zero, this output valid signal abolishes. The clock cycle is required to be greater than 10 ms; And the minimum pulse width is 5ms.

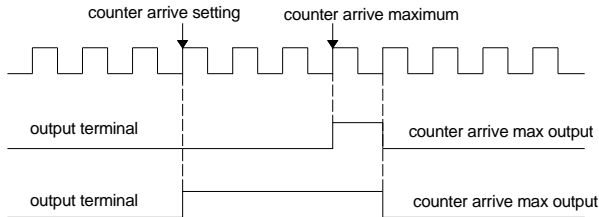

F-41	VS1 terminal input voltage lower limit	Range: 0.00V-[F-42]	Default: 0.50V
F-42	VS1 terminal input voltage upper limit	Range:[F-41]-10.00V	Default: 9.50V
F-43	VS1 terminal input voltage gain	Range: 0.01-5.00	Default: 1.00

VS1 terminal input voltage lower limit This function defines the minimum signal of the analog input terminal (VS1) receiving. Frequency inverter will automatically filter the voltage signal whose value is lower than this value.

VS1 terminal input voltage upper limit This function defines the maximum signal of the analog input terminal (VS1) receiving. Frequency inverter will automatically filter the voltage signal whose value is higher than this value.

VS1 terminal input voltage gain This function is used to amplify or reduce the (VS1) terminal input analog value.

F-44	VS2 terminal input voltage lower limit	Range: -10.00V-[F-45]	Default: 0.50V
F-45	VS2 terminal input voltage upper limit	Range: [F-44]-10.00V	Default:9.50V
F-46	VS2 terminal input voltage gain	Range: 0.01-5.00	Default:1.00
F-47	VS2 terminal input zero offset	Range: -1.00V-1.00V	Default:0.00V
F-48	VS2 terminal input bipolar adjust and direction control	Range: 0,1,2	Default: 0

F-49	VS2 terminal input bipolar control zero hysteresis band	Range: 0.00V-3.00V	Default: 0.20V
------	---	--------------------	----------------

VS2 terminal input voltage lower limit This function defines the minimum signal which received by the analog input terminal (VS2). Frequency inverter will automatically filters the voltage signal whose value is lower than this value.

VS2 terminal input voltage upper limit This function defines the maximum signal which received by the analog input terminal (VS2). Frequency inverter will automatically filter the voltage signal whose value is higher than this value.

VS2 terminal input voltage gain S2 This function is used to amplify or reduce the (VS2) terminal analog value.

VS2 terminal input zero offset This function is used to adjust the (VS2) terminal zero point in the bipolar control mode; Its adjustment direction is opposite to the actual zero point. If the actual input voltage is +0.5V, at this moment, users should set the zero offset as -0.5V to let the voltage corresponding to the zero voltage (only valid when [F-48] is set as 1 or 2)

VS2 terminal input bipolar adjust and direction control

0: Bipolar adjust and direction control both invalid: the output frequency is determined by the input voltage of terminal (VS2).

1: Bipolar adjust and direction control both valid: the output frequency of frequency inverter is determined by the absolute value of amplitude of the input voltage of terminal (VS2). While output phase sequence (machine direction) is determined by the polar of the input voltage terminal (VS2), frequency inverter neglects its direction turning setting orders only except this order. When the voltage (VS2) > 0, frequency inverter outputs positive phase sequence, machine forward rotates. When voltage (VS2) < 0, frequency inverter outputs negative phase sequence, machine reverses.

When the parameter [E-46] is set as 2 prohibit reverse, if (VS2) < 0, machine reverse, frequency inverter will operate as 0 frequency.

The Bipolar analog input signal (-10V ~ 0V ~ +10V) is stipulated as following: 0V ~ +10V step is corresponding to from [F-56] input frequency lower limit setting to [F-57] input frequency upper limit setting, forward running; 0V ~ -10V step is corresponding to from [F-56] input frequency lower limit setting to [F-57] input frequency upper limit setting, reverse running.

Tips: In two channels combination, bipolar signal will carry out signed calculation based on the combination mode selection. Negative voltage and frequency DW signal are negative signal. All other input signals of VS2 are positive signal. If calculation result is positive, the machine forward rotates. If the calculation result is negative, machine runs in reverse direction.

2: Bipolar adjust valid, direction control invalid: In two channels combination, it used to add or reduce frequency of another channel. It carries out signed calculation while combination. If the result is positive, machine runs according to [E-01] given direction. If the result is negative, the output frequency is '0'. Bipolar signal takes part in frequency calculation, do not change or decide the direction of the machine.

VS2 terminal input bipolar control zero hysteresis band This function is used in the bipolar control mode to adjust the (VS2) terminal zero point corresponding voltage range. If the zero point range is set as -1V ~ +1V, the hysteresis band should be set as 1V. (only valid when it is set as '1' of [F-48] parameter)

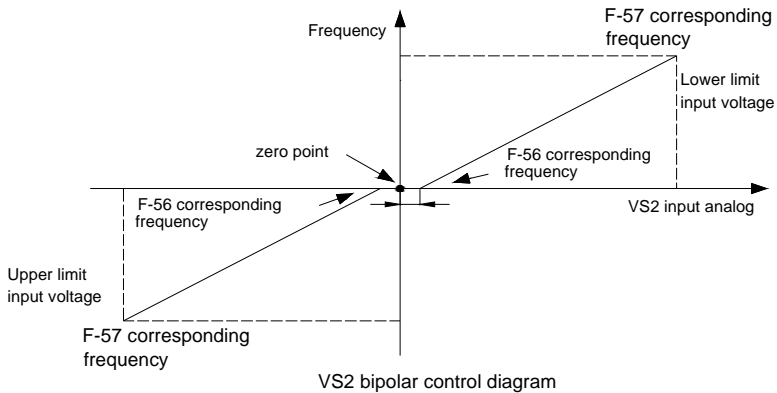
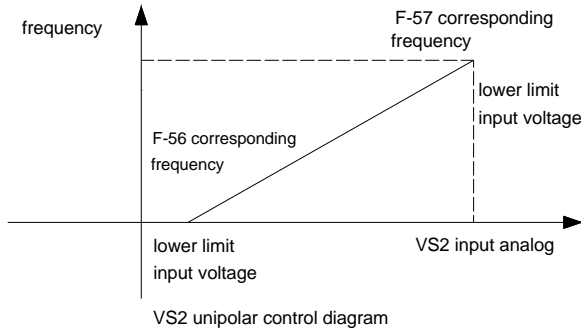

Tip: When (VS2) is used as PID given or feedback channel, the function of bipolar is invalid. At this moment, the usage of (VS2) terminal is the same with the (VS1) terminal. Namely, when (VS2) <0, frequency inverter think the input of this port is 0.

F-50	AS terminal input current lower limit	Range: 0.00mA-[F-51]	Default: 4.20mA
F-51	AS terminal input current upper limit	Range:[F-50]-20.00mA	Default: 19.50mA
F-52	AS terminal input current gain	Range: 0.01-5.00	Default: 1.00

AS terminal input current lower limit This function defines the minimum signal which received by the analog input terminal(AS),frequency inverter will automatically filters the current signal whose value is lower than this value; For example, if the factory setting of this value '4.00',4.00-20.00mA input current is available.

AS terminal input current upper limit This function defines the maximum signal which received by the analog input terminal (AS), frequency inverter will automatically filters the current signal whose value is higher than this value.

AS terminal input current gain This function is used to amplify or reduce the (AS) terminal.

F-53	Pulse input frequency lower limit	Range: 0.0KHz-[F-54]	Default: 0.0KHz
F-54	Pulse input frequency upper limit	Range:[F-53]-50.0KHz	Default:10.0 KHz
F-55	Pulse input frequency gain	Range: 0.01-5.00	Default: 1.00

Terminal input frequency lower limit This function defines the minimum frequency received by the analog input terminal (PUL). Frequency inverter will automatically filter the frequency whose value is lower than this value;

Terminal input frequency upper limit This function defines the maximum frequency received by the analog input terminal (PUL). Frequency inverter will automatically filter the frequency whose value is higher than this value.

Terminal input frequency gain This function is used to amplify or reduce the (PUL) terminal input signal.

F-56	Input lower limit correspond setting frequency	Rang: 0.00Hz-[F-57]	Default: 0.00Hz
F-57	Input upper limit correspond setting frequency	Range: [F-56]-maximum frequency	Default: 50.00Hz

These two parameters stipulate the corresponding relation between the external input analog value, upper/lower limit of the pulse signal and frequency.

F-58	Input signal characteristic selection	Range:0000-1111	Default:0000
------	---------------------------------------	-----------------	--------------

LED unit digit: VS1 input characteristic selection

0: Positive characteristic 1: Negative characteristic

LED ten digit: AS input characteristic selection

0: Positive characteristic 1: Negative characteristic

LED hundred digit: VS2 input characteristic selection

0: Positive characteristic 1: Negative characteristic

Tips: When (VS2) opens bipolar function ([F-48]is set as 1 or 2), this parameter is invalid.

LED thousand digit: Pulse input characteristic selection

0: Positive characteristic 1: Negative characteristic

When in positive characteristic stage, lower limit of external analog input value and the pulse signal corresponds to [F-56], upper limit of exterior analog input value and the pulse signal corresponds to [F-57].

When in negative characteristic stage, lower limit of exterior analog input value and the pulse signal corresponds to [F-57], upper limit of exterior analog input value and the pulse signal corresponds to[F-56].

As shown in the Fig. [F-56] (fmin), the biggest analog input and the pulse signal corresponding frequency setting means their upper limit value corresponding frequency setting, As shown in the Fig. [F-57] (fmax).

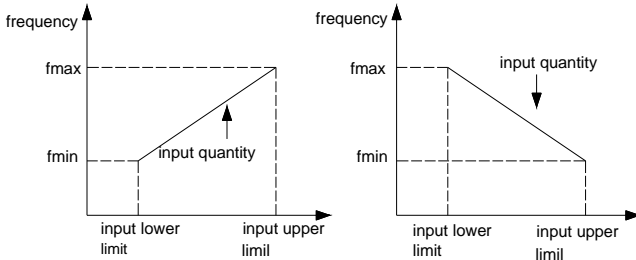

Relationship between frequency setting and input quantity

F-59	Terminal analog input filtering time constant	Range: 0.01-5.00s	Default: 0.50s
------	---	-------------------	----------------

This is defined as the size of the input analog quantity signal filtering, for the purpose of eliminating the interference signal. The longer filtering time is, the stronger anti-interfere ability is, but the respond speed slow down; The shorter filter time is, the weaker anti-interfere ability is, but the respond speed become faster;

F-60	Output terminal(AO1)selection	Range: 0-7	Default: 1
F-61	Output terminal(AO2)selection	Range:0-7	Default: 3

Output signal (A01) and (A02) mode is programmed by **[F-62]**

- 0: Output signal disable
- 1: Output frequency/speed
- 2: Output current
- 3: Given frequency/speed reference
- 4: PID given value
- 5: PID feedback value
- 6: DC bus voltage
- 7: Output voltage

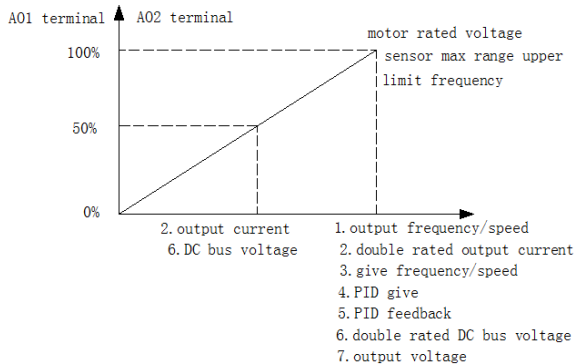

A01/A02 port and output quantity relationship

Tips: when (A02) port is frequency pulse output or 4-20mA output, '0%' corresponding output quantity is not zero.

F-62	Analog output signal selection	Range: 0000-0023	Default: 0003
------	--------------------------------	------------------	---------------

LED unit digit: A02 output signal mode selection

0: Frequency pulse train output default setting for 0.2KHz to 10.0KHz;

1:0-20mA

2:4-20mA

3:0-10V

LED ten digit: A01 output signal mode selection

0:0-10V

1:0-20mA

2:4-20mA

LED hundred digit: Reserve**LED thousand digit: Reserve**

Tip: After output mode selected by software configured, it also need to select by J1, I2, J3, J4, J5, terminals pin short connection. Refer to following for selecting in detail.

A02 selects for frequency pulse train output, need select J1 among J1, J2, J3 dial switching.

A02 selects for 0-20mA or 4-20mA output signal, need select J2 among J1, J2, J3 dial switching.

A02 selects for 0-10V output signal, need select J2 among J1, J2, J3 dial switching.

A01 selects for 0-20mA or 4-20mA output signal, need make J5 short connection, J4 disconnect.

A01 selects for 0-10V output signal, need make J4 short connection, J5 disconnect.

In the factory default setting of A01 and A02 output signal is 0-10V analog output. If need other output mode, please configure the software and hardware according requirement.

F-63	AO1 output signal gain	Range: 25%-200%	Default: 100%
F-64	AO2 output signal gain	Range: 25%-200%	Default: 100%

Used to adjust AO1 terminal output analog value and AO2 output signal value.

F-65	AO1 output signal zero adjust	Range : -10%-10%	Default: 0.0
F-66	AO2 output signal zero adjust	Range : -10%-10%	Default: 0.0

Used to adjust the output signal zero point of (AO1) terminal and (AO2) terminal. It is invalid to adjust this value when (AO2) is frequency pulse output.

F-67	Keypad potentiometer input lower limit voltage	Range: 0.00V-[F-68]	Default: 0.20V
F-68	Keypad potentiometer input upper limit voltage	Range:[F-67]-5.50V	Default: 4.80V
F-69	Keypad potentiometer gain	Range: 0.00-5.00	Default: 1.00

Keypad potentiometer input voltage lower limit This function defines the minimum signal received by the keyboard potentiometer. Frequency inverter will automatically filters the signal whose value is lower than this value;

Keypad potentiometer input voltage upper limit This function defines the maximum signal received by the keyboard potentiometer. Frequency inverter will automatically filters the signal whose value is upper than this value.

Keypad potentiometer gain This function is used to amplify or reduce keyboard potentiometer input analog quantity.

Tips: Keypad potentiometer input voltage upper limit is corresponding to frequency upper limit [E-10], Keyboard potentiometer input voltage upper limit is corresponding to 0.00 Hz.

F-70	UP/DW terminal preset frequency	Range: 0.00Hz-Maximum frequency	Default:0.00Hz
F-71	UP/DW Power-off memorized frequency	Range: 0.00Hz-Maximum frequency	Default:0.00Hz

The starting frequency output when inverter runs in UP/DW control mode. It is enabled only [F-07] LED ten digit has been set for 1 or 2.

When the [F-07] LED ten digit sets for 1, [F-71] parameters will memorize the last UP and DOWN control momentary frequency. User can review and modify the last stop momentary frequency via [F-71] in stop status.

When the [F-07] LED ten digit sets for 2, the starting frequency can be preset via [F-70] parameters in UP/DW control.

8.3. Special Function Parameters

H-01	User setting voltage V1	Range: 0.0%-[H-03]	Default: 3.0%
H-02	User setting frequency F1	Range : 0.00Hz-[H-04]	Default:1.00Hz
H-03	User setting voltage V2	Range:[H-01-H-05]	Default: 28.0%
H-04	User setting frequency F2	Range:[H-02-H-06]	Default: 10.00Hz
H-05	User setting voltage V3	Range:[H-03-H-07]	Default: 55.0%
H-06	User setting frequency F3	Range:[H-04-H-08]	Default: 25.00Hz
H-07	User setting voltage V4	Range:[H-05-H-09]	Default: 80.0%
H-08	User setting frequency F4	Range:[H-06-H-10]	Default: 37.50Hz
H-09	User setting voltage V5	Range:[H-07]-100.0%	Default: 100.0%
H-10	User setting frequency F5	Range:[H-08]-maximum frequency	Default: 50.00Hz

User define V/F curve:

User can define 1st, 2nd , 4th , 5th point of V/f curve percentage for output voltage reference, corresponding to F1/F2/F3/F4/f frequency point separately. User also can define 1st, 2nd , 3rd , 4th , 5th of frequency point to correspond V1,V2, V3, V4, V5.

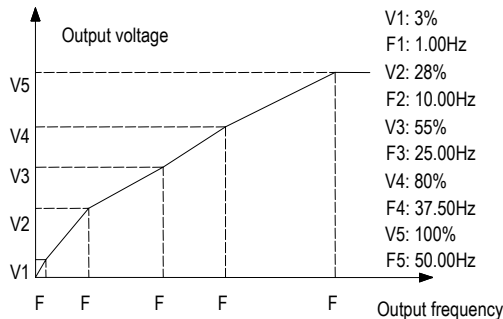

User defines V/f curve schematic

This parameter setting must satisfy the following conditions:

$0 \leq F1 \leq F2 \leq F3 \leq F4 \leq F5 \leq$ maximum frequency upper limit; $0 \leq V1 \leq V2 \leq V3 \leq V4 \leq V5 \leq 100\%$

V1, V2, V3, V4, V5 is base on the frequency rated output voltage

H-11	PID output characteristic	Range: 0, 1	Default: 0
------	---------------------------	-------------	------------

PID control is a common method used in the process control. The output frequency is adjusted via a series of proportion, integral, differential calculation of difference value between feedback value of controlled object and PID given value, make up a negative feedback PID adjustment to achieve a goal which controlled objected stabilizes on the PID given value.

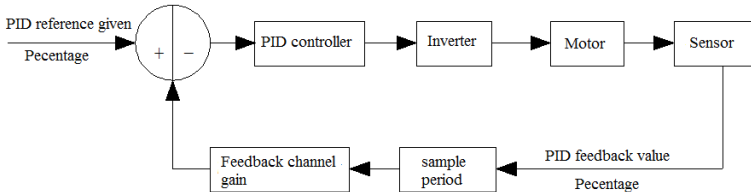

PID control diagram

0: Positive characteristic Suitable for occasions where maintains the PID balance by reducing the frequency inverter output frequency while the PID feedback quantity is greater than PID given value. Such as apply in constant pressure water supply, gas supply and tension control of winding application.

1: Negative characteristic Suitable for occasions where maintains the PID balance by increasing the frequency inverter output frequency while the PID feedback value is greater than PID given value. Such as apply in central air-conditioning constant temperature control and tension control of unwinding.

While frequency inverter receiving the operation command, frequency inverter will automatically control output frequency after calculating for the given signal and feedback signal of the terminal according to the PID setting control mode.

While the PID controls to cancel the terminal connection, frequency inverter will convert the given signal to output frequency directly without PID control.

H-12	PID controller given signal sources	Range: 0-6	Default: 1
------	-------------------------------------	------------	------------

- 0: Keypad potentiometer Given by the potentiometer of keypad analog signal.
- 1: PID keypad digital given Given value configured by **[H-16]** in general PID control
- 2: External terminal VS1 Given by the external terminal (VS1) (0V-10V) analog signal.
- 3: External terminal AS Given by the external terminal (AS) (4-20mA) analog signal.
- 4: External terminal VS2 Given by the external terminal (VS2) analog signal. (**[F-48]** can't be set for 1 or 2).
- 5: External pulse signal Given by the external terminal (PUL) pulse frequency signal.
- 6: RS485 interface Given by RS485 communication interface receiving signal.

H-13	PID controller feedback signal source	Range: 0-3	Default: 1
------	---------------------------------------	------------	------------

- 0. External terminal VS1 Set by the external terminal (VS1) (0V-10V) analog signal.
- 1. External terminal AS Set by the external terminal (AS) (4-20mA) analog signal.
- 2. External terminal VS2 (bipolar invalid) Set by the external terminal (VS2) analog signal. (**[F-48]** can't be set for 1 or 2).
- 3. External pulse signal Set by the external terminal (PUL) pulse frequency signal.

Note: PID controller given signal source and PID controller feedback source can't be set in the same channel, otherwise PID is disabled.

H-14	PID preset frequency	Range: 0.00Hz-maximum frequency	Default: 0.00Hz
H-15	PID preset frequency running time	Range: 0.1-6500.0s	Default: 0.0s

This function make frequency inverter accelerate to PID preset frequency [H-14] with acceleration time 1 after PI operation starts, and will keep running for PID preset frequency running time [H-15] given, and then executes the PID close loop operation.

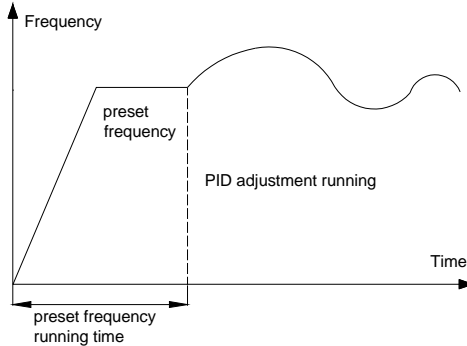

PID preset frequency running time diagram

H-16	PID keypad digital given	Range: 0.0%-100.0%	Default:50.0%
------	--------------------------	--------------------	---------------

Only when [H-12] parameters is set for 1,this parameter is valid. Take the sensor maximum measuring range [H-18] as a benchmark. When this parameter is changed, PID given value of monitoring target will automatically synchronize change.

H-17	PID channel gain	Range: 0.01-5.00	Default: 1.00
------	------------------	------------------	---------------

This function is used to amplify or reduce the input analog value of feedback channel

H-18	Sensor maximum measuring range	Range:1.0-100.0	Default:100.0
------	--------------------------------	-----------------	---------------

This function is used to adjust the display data of PID given value and PID feedback value.

Actual LED display value= $\frac{\text{given (feedback) signal} - \text{lower input limit}}{\text{Upper input limit} - \text{lower input limit}} \times \text{sensor largest range}$

For example in pressure control, if it is set for sensor maximum pressure, the display value is actual pressure value. Assumes that take external terminal (VS1) for feedback single input channel, when VS1 upper limit voltage is 9V, the lower limit is 0.5V, the present feedback voltage is 4.5V, the maximum sensor measure range is 20mpa.

$$\text{LED display value} = (4.5 - 0.5) \times 20 / (9 - 0.5) = 9.4 \text{ mpa}$$

H-19	Proportion gain P	Range: 0.1-100.0	Default: 20.0
H-20	Integral time constant I	Range: 0.1-100.0s	Default: 2.0s
H-21	Differential gain D	Range: 0.0-10.0	Default: 0.0

Adjusting parameters in PID control function, these parameters should be set according to actual system characteristic in respectively.

Proportion gain P: This parameter determines the impact degree of Proportion gain P respond to deviations. When gain is large, it responds quickly, but would bring out oscillation. When gain is small, respond will delay.

Integral time constant I: It decides the size of respond effect for Integral time I. When the integral time is big, the respond is slow, In addition, anti-external interference is become weaker. If the integral time is small, the respond speed is quick. But oscillation would occur if it is set too small.

Differential gain D: When the deviation of PID feedback value and PID given value changes, The output and the change rate of deviation are proportionally adjusted. This adjustment is only related to the direction and size of the deviation change and has nothing to do with the direction and size of the deviation itself. While the feedback signal changes, differential adjustment is used to adjust according the change trend to restrain the change of feedback signal. Please be careful to use the differential adjustment. Because it will apply the system interference, especially for a higher changing frequency interference.

H-22	Sampling period	Range: 0.01-60.00s	Default: 0.10s
------	-----------------	--------------------	----------------

This parameter is only valid for the sampling period of feedback value. The regulator will calculates a time in every sampling period. The small sampling period, the quicker respond time.

H-23	PID control deviation limit	Range: 0.0%-20.0%	Default: 0.0%
------	-----------------------------	-------------------	---------------

The maximum deviation allows for PID feedback value to PID given value. PID will be stop, keep output constant when the feedback value within this deviation range. It will coordinate the contradiction between the accuracy of system output and stability with using this function properly.

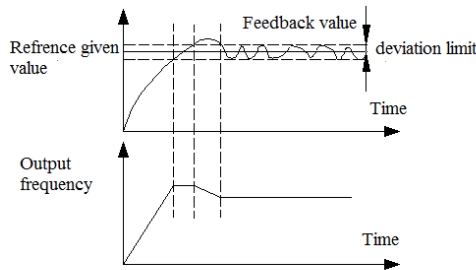

PID control deviation limit diagram

H-24	Starting threshold value	Range:0.0%-Sleep threshold value	Default:0.0%
H-25	Sleep threshold value	Range: Starting threshold value-100.0%	Default:100.0%

Starting threshold value: When inverter goes into sleep mode, inverter restarts should require PID feedback value less than starting threshold value setting. If the starting threshold value is set too high, inverter will start and stop frequently. If it set too low, it will cause pressure not enough. This parameter is defined as percentage of PID feedback value to sensor maximum measuring range account for.

Sleep threshold value: This parameter use as a standard value for adjusting system if go to sleep mode when no need working. It is that inverter always standby for sleep detecting, if PID feedback value higher than or equal to PID given setting value is detected, and try to keep holding for a while in setting value around, inverter will start sleep detecting. If the feedback value higher than sleep threshold value during the sleep detecting mode, inverter will reduce the output frequency to lower limit frequency, and keep outputting lower limit frequency for a while, and then reduce to 0Hz, go into sleep mode. If feedback value lower to sleep threshold during above process, sleep detecting will be disable, go back to PID adjusting working. Smaller setting of this parameter, system will go to sleep mode easier. When it is set for 100.0%, the system will not go to sleep mode. This parameter is defined as percentage of PID feedback value to sensor maximum measuring range account for. This function only is enabled in constant pressure PID control.

H-26	Alarm upper limit value	Range: Alarm lower limit value-100.0%	Default: 100.0%
H-27	Alarm lower limit value	Range: 0.0%-Alarm upper limit value	Default: 0.0%

While PID feedback reaches or exceeds the setting value, if any output terminals **[F-30-F-32]** is set as 15, (PID feedback value upper limit alarming), it outputs alarm signal; This parameter is defined as percentage of the maximum measuring range of the sensor that the PID feedback value accounts for.

While PID feedback reaches or under the setting value, if any output terminals **[F-30-F-32]** is set as 16, (PID feedback quantity upper limit alarming), it outputs reaching signal; This parameter is defined as percentage of the largest range of the sensor that the PID feedback quantity accounts for.

This function only is enabled in constant pressure PID control.

H-28	Sensor disconnection detection	Range: 0.0%-20.0%	Default: 0.0%
H-29	Sensor disconnection alarm operation selection	Range: 0,1	Default: 0

When the frequency inverter is in the PID control mode, this function is valid; If the detection feedback signal is less than **[H-28]**, the sensor is deemed to be open circuit. At this moment, if any one of output terminal **[F-30-F-32]** is set as '17' (sensor disconnect), the output signal is valid; This parameter is defined as the percentage of the sensor maximum range that the feedback signal accounts for.

Sensor disconnection alarm running selection

0:Continuous operation

1:Close down

In the process of PID adjustment, while system detects sensor open circuit, this parameter is used to choose whether frequency inverter stop working. If choose working on ,frequency inverter will cancel closed-loop control, with PID given values as frequency output; If choose close down, when the system detects the alarm which is mentioned above, the inverter will stop output and display the malfunction information immediately.

The feedback sensor malfunction is displayed as "SEn". When it detects the PID feedback quantity is greater than the setting of **[H-28]**, the feedback sensor fault is deemed to be vanish, and system restores PID closed-loop control.

H-30	Upper limit threshold	Range: lower limit threshold-100.0%	Default: 100.0%
H-31	Lower limit threshold	Range:0.0%-upper limit threshold	Default: 0.0%

This parameter will limit PID given during upper limit threshold and lower limit threshold range. This parameters is defined the ratio of upper limit threshold, lower limit threshold to maximum measuring range. This function only is enabled in constant pressure PID control.

H-32	Program running mode	Range:0-5	Default: 0
------	----------------------	-----------	------------

0. Single cycle running (time by second)

While receiving running instructions, the frequency inverter starts operation from the 1st step speed and direction.

The acceleration/deceleration time are selected by parameter **[H-35-H-42]**; Run time is up to parameter **[H-43-H-50]**; The time unit is second. While the first step time up, it shifts to the next step speed. The time, direction, acceleration/deceleration time of each step speed can be programmed; While finishing the 8th section speed running, frequency inverter will output "0" frequency. If one step running time is set to zero, it will skip over this step.

1. Continuous cycle running (time by second)

After the frequency inverter finishing 8th section speed running, return to the 1st step speed to begin to work for uninterrupted cycles. Running direction and acceleration/deceleration time are selected by the parameter **[H-35-H-42]**; Run time is set up by parameter **[H-43-H-50]**, the time unit is second.

2: single cycle, continuous running (time by second)

After finishing a single cycle running, the frequency inverter running don't stop. It works on at the final step speed whose running time is not zero. Running direction and acceleration/deceleration time are selected by the parameter **[H-35-H-42]**; Run time is set up by parameter **[H-43-H-50]**, the time unit is second.

3. Single cycle running (time by minute)

Direction and acceleration/deceleration time are selected by parameter **[H-35-H-42]**; Running time is set up by parameter **[H-43-H-50]**; The time unit is minute. The others are identical with mode '0'.

4: continuous cycle (time by minute)

Running direction and acceleration\deceleration time are selected by the parameter **[H-35-H-42]**; Running time is set up by parameter **[H-43-H-50]**; The time unit is minute; The others are identical with mode '1'.

5: Single cycle, continuous running (time by minute)

Running direction and acceleration/deceleration time are selected by the parameter **[H-35-H-42]**; Running time is set up by parameter **[H-50-H-50]**; The time unit is minute; The others are identical with mode "1"

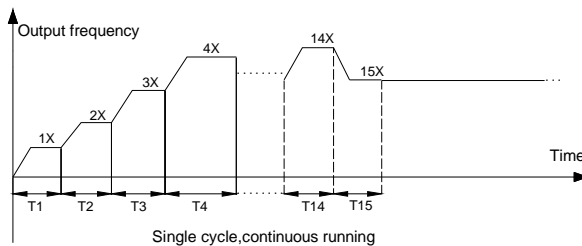
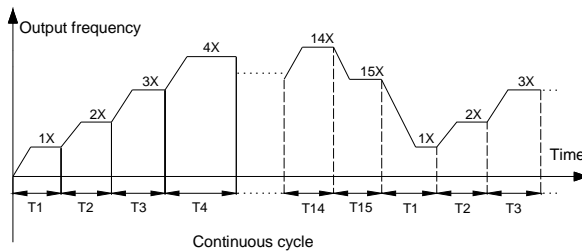
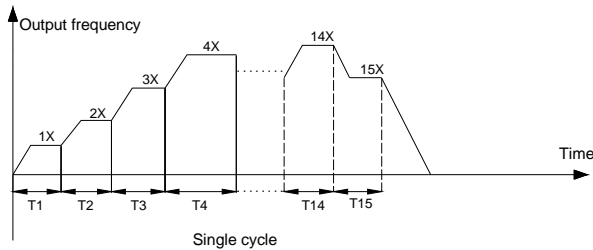

H-33	Program run breakpoint restore mode selection	Range: 0,1,2	Default: 0
------	---	--------------	------------

0: Running at the first step speed

1: Continue to run with breakpoint running frequency and retiming.

2: Continue to run with the breakpoint running frequency and residual time.

This parameter defines the restart running mode after break off due to various reasons (stop, fault, power fail).

If select 0 mode, inverter restarts running with first step speed.

If select 1 mode, inverter restarts running from break of running step, and start timing.

If select 2 mode, inverter restarts running from break of running step, and run with residual time after break off.

H-34	Program running state power down memory selection	Range: 0,1	Default:0
------	---	------------	-----------

0: NO power down memory

1: power down memory

This parameter defines if inverter will memorize current program running status after power down in program running mode (running step, residual time of current step, acceleration/deceleration and running direction, etc). If select power down memory, and combine with **[H-33]** parameters can defines next restore program running mode when power on. It need to protect inverter will continue running with before power off running status, this parameters should set to 1.

H-35	1 step speed direction and accel/decel time	Range: 0-7	Default: 0
H-36	2 step speed direction and accel/decel time	Range: 0-7	Default: 1
H-37	3 step speed direction and accel/decel time	Range: 0-7	Default: 2
H-38	4 step speed direction and accel/decel time	Range: 0-7	Default: 3
H-39	5 step speed direction and accel/decel time	Range: 0-7	Default: 4
H-40	6 step speed direction and accel/decel time	Range: 0-7	Default: 5
H-41	7 step speed direction and accel/decel time	Range: 0-7	Default: 6
H-42	8 step speed direction and accel/decel time	Range: 0-7	Default: 7

In the program running, use to set 8 steps rotation direction and acceleration /deceleration time respectively.

Setting code	Description
0	Forward; Acceleration time 1/Deceleration time 1
1	Forward; Acceleration time 2/Deceleration time 2
2	Forward; Acceleration time 3/Deceleration time 3
3	Forward; Acceleration time 4/Deceleration time 4
4	Reverse; Acceleration time 1/Deceleration time 1
5	Reverse; Acceleration time 1/Deceleration time 2

6	Reverse; Acceleration time 1/Deceleration time 3
7	Reverse; Acceleration time 1/Deceleration time 4

H-43	1 step speed running time T1	Range: 0.0-6000.0	Default: 10.0
H-44	2 step speed running time T2	Range: 0.0-6000.0	Default: 10.0
H-45	3 step speed running time T3	Range: 0.0-6000.0	Default: 10.0
H-46	4 step speed running time T4	Range: 0.0-6000.0	Default: 10.0
H-47	5 step speed running time T5	Range: 0.0-6000.0	Default: 10.0
H-48	6 step speed running time T6	Range: 0.0-6000.0	Default: 10.0
H-49	7 step speed running time T7	Range: 0.0-6000.0	Default: 10.0
H-50	8 step speed running time T8	Range: 0.0-6000.0	Default: 10.0

Use to set 8 steps speed running time, unit of time is set by [H-32] parameters.

H-51	Differential frequency Δf in swing frequency	Range:0.00Hz-20.00Hz	Default:2.00Hz
------	--	----------------------	----------------

During the swing frequency operation, the FOR/REV switching function will be forbidden, running direction is programmed after stop only. f1 is the setting value of [F-09]; f2 is the setting value of [F-10]; Acceleration time T1 of the amplitude is the setting value of [F-24]; And the acceleration time T2 of the amplitude is the setting value of [F-25].

The acceleration/deceleration time in swing frequency running is defined by acceleration/deceleration time 1. When using the swing frequency running function, frequency inverter will run with the acceleration/deceleration time 1 to the f1 setting frequency, then begin swing frequency running. While stop, frequency inverter will run for acceleration/deceleration time 1 from the running frequency to stop. Acceleration/deceleration time of the amplitude is defined by acceleration/deceleration time 2. It is defined as the same as acceleration/deceleration time 1. The parameter settings in the swing frequency running should satisfy the following formula request, otherwise display "Err5".

$$\begin{cases} f1 > f2 + \Delta f \\ f2 \geq 0.50\text{Hz} \\ 0 \leq \Delta f \leq 20.00\text{Hz} \end{cases}$$

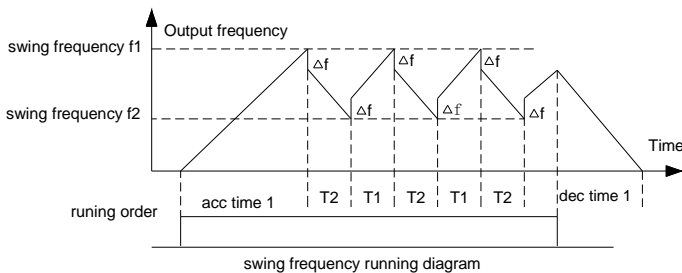

H-52	Motor rated power	Range: 0.4-1100.0KW	Default: ※
H-53	Motor rated frequency	Range: 0-600.00Hz	Default: 50.00Hz

H-54	Motor rated speed	Range: 0-18000RPM	Default: ※
H-55	Motor rated voltage	Range: 0-1500V	Default: ※
H-56	Motor rated current	Range: 0.1-1000.0A	Default: ※
H-57	Motor no load current	Range: 0.01-650.00A	Default: ※
H-58	Motor stator resistor	Range: 0.001-65.000Ω	Default: ※
H-59	Motor rotor resistor	Range: 0.001-65.000Ω	Default: ※
H-60	Motor stator inductance	Range: 0.1-6500.0mH	Default: ※
H-61	Motor rotor mutual inductance	Range: 0.1-6500.0mH	Default: ※

[H-52] uses to set motor rated power, unit is 0.1kw. Refer to motor nameplate to configure this parameter. Inverter will automatically select corresponding default value as [H-53-H-61] default value after every changing of this parameter. [H-57-H-61] parameters will be modified after motor auto tuning when highly accuracy motor control is required. The motor parameters [H-52-H-56] must be set properly before perform motor auto tuning.

H-62	Motor auto tuning selection	Range:0-2	Default: 0
------	-----------------------------	-----------	------------

0. Null operation. No need perform motor parameters auto tuning.

1. Rotational motor auto tuning. Please make sure configure [H-52-H-56] parameters follow motor name plate correctly before perform motor auto tuning. After executing rotary motor auto tuning, motor will locate stationary state, it will measuring the stator resistor, rotor resistor and stator& rotor inductance of AC asynchronous motor first, and then motor will run, and perform no load current and mutual inductance of stator& rotor measure automatically, write the measured value to [H-57-H-61]. Motor parameters will be reset after auto tuning automatically.

Press the running key to start rotational auto tuning after parameters setting, 'T-02' will be show in the digital keypad during then running, motor will be stop after auto tuning finish, inverter will restore ready status.

2. Stationary auto tuning Please make sure configure [H-52-H-56] parameters follow motor name plate correctly before perform motor auto tuning. After executing stationary motor auto tuning, motor will locate stationary state, it will measuring the stator resistor, rotor resistor and stator& rotor inductance of AC asynchronous motor first, and put the measured parameters to correspond parameters.

Press the running key to start rotational auto tuning after parameters setting, 'T-01' will be show in the digital keypad, motor will stop after auto tuning, and inverter will restore to ready status.

Note: 1. Must disconnect load from motor before set [H-62] for 1 to execute rotational motor auto tuning. It is forbidden perform auto tuning with load.

2. For some application which not easy to execute rotational auto tuning (the motor can't dispatch from load) or no need high performance control for motor, please select stationary auto tuning or no need perform auto tuning. Please make sure configure [H-52-H-56] parameters with motor nameplate correctly.

4. Make sure motor should stand in stop state before execute the auto tuning, otherwise auto tuning can't carry out normally.

5. It will alarm E.TE1 fault if stationary auto tuning fails, it will alarm E.TE2 if rotational auto tuning fails.

H-63	Motor magnetic saturation coefficient 1	Range: 0-9999	Default: ※
H-64	Motor magnetic saturation coefficient 2	Range: 0-9999	Default: ※
H-65	Motor magnetic saturation coefficient	Range: 0-9999	Default: ※

[H-63-H-65] parameters use to adjusting the motor magnetic saturation in vector control mode, improve the motor overload capacity and rung stability.

H-66	Linkage main station setting	Range: 0,1,2	Default: 0
------	------------------------------	--------------	------------

0: Local machine configure as linkage slave station

- 1: Main station control mode 1. Sent frequency reference and running command of main inverter to slave inverter.
 2: Main station control mode 2. Sent output frequency and running command of main inverter to slave inverter.
 When this frequency configure for main station, it has linking control function, enable to control other AC70 inverter of network synchronous running.

H-67	Local inverter address	Range: 1-247	Default: 1
------	------------------------	--------------	------------

Uses to define communication address of local machine when it has been set for slave one. It makes no sense if it is set for main inverter.

H-68	Data format	Range: 0,1,2,3	Default: 3
------	-------------	----------------	------------

- 0: (N,8,1), no check, data bit: 8, stop bit: 1
 1: (E,8,1), even parity check, data bit: 8, stop bit: 1
 2: (O,8,1), odd parity check, data bit: 8, stop bit: 1
 3: (O,8,2), no check, data bit: 8, stop bit: 2

H-69	Baud rate	Range:0- 5	Default:3
------	-----------	------------	-----------

- 0:1200bps
 1:2400bps
 2:4800bps
 3:9600bps
 4:19200bps
 5:38400bps

H-70	Communication setting frequency ratio	Range:0.01-5.00	Default:1.00
------	---------------------------------------	-----------------	--------------

Take frequency reference from upper controller multiply this parameter for this machine frequency reference. Modification with proportional scale for given frequency from upper controller is available.

H-71	Time of communication time out	Range:0.0-6500.0s	Default:10.0s
------	--------------------------------	-------------------	---------------

If the interval time between a communication and the next communication exceeds communication overtime time, it is considered there is communication disconnection fault, malfunction disconnection action mode is decided by the [H-72].

H-72	RS485 communication broken responding mode	Range:0-2	Default: 1
------	--	-----------	------------

LED“0” digit: RS485 communication broken responding mode

0: giving alarm and free stop When the inverter setting given communication command don't receive next frame command or any other communication command respond over [H-17] given time, inverter will giving alarm and free stop .

1: No alarm and continue running Inverter don't make any fault detect, continue running with last communication

command .

2. No alarm but stop When the inverter setting given communication command doesn't receive next frame command or any other communication command respond over [H-17] given time, inverter stop running.

LED "00" digit: Communication write operation mode.

0: Reply for write operation

1: No reply for write operation

LED "000" digit: Reserve

LED "0000" digit: Reserve

Note: When inverter has been set for main machine, don't perform RS485 communication broken checking.

H-73	Respond relay	Range: 0.000-1.000s	Default: 0.005s
------	---------------	---------------------	-----------------

This parameter defines the intermediate interval time between the frequency inverter receiving the data and responding data back to the upper control. If the response delay time is shorter than the system handling time, the response time should according to the system; If the response delay time is longer than the system handling time, after system processing the data, it waits until the response delay time is up, then sends data to the upper controller.

H-74	Instantaneous stop decel. respond voltage lower limit	Range: 0%-200%	Default: 20%
H-75	Instantaneous stop decel. respond voltage upper limit	Range: 0%-200%	Default: 90%
H-76	Instantaneous stop decel. gain	Range: 0.01-10.00	Default:2.00
H-77	Voltage recover stability time	Range: 0.0-100.0s	Default:2.0s

This function enable frequency inverter reducing the output frequency when power fails instantaneous or voltage lower suddenly, compensate voltage lowed with energy feedback from load, to maintain inverter continue running in shortly.

When the input voltage lower to [H-74], inverter will start to reduce speed and DC bus voltage rise. When the input voltage recovers to [H-75], speed reducing will stop. When the current speed keep stable running after [H-77] setting time, inverter will accelerate to frequency reference given.

[H-76] is defines as deceleration gain, the bigger setting, the quicker voltage rising, which suitable for small inertia load. If this parameters is set for small, the voltage recovery rising slowly, which suitable for big inertia.

H-78	Torque compensation upper limit	Range: 0.00-60.00%	Default:50.00%
------	---------------------------------	--------------------	----------------

This parameters is valid only in vector control mode, uses for controlling the torque compensation upper limit. Take the rated inverter voltage as reference benchmark for compensation voltage.

H-79	Output terminal external control status	Range: 0-9999	Default: 0
------	---	---------------	------------

H-80	Reserve		
------	---------	--	--

Appendix 1: Appendix

9.1 Appendix 1: Function Code Simple List

“●”: Stand for this parameter can be modified in running mode.

“○”: Stand for this parameter can not be modified in running mode.

“×”: Stand for this parameter is read only, can't be modified.

“-”: Stand for factory authority parameters. Veichi setting is available only.

“※”: Stand for this parameter is related to frequency inverter model.

Basic function code group

Code function	Function name	Setting range and definition	Factory default	property	Refer to page	Communication code
E-00	Control method selection	0: Open loop vector control without PG 1: V/F control mode	1	○	69	100H
E-01	Running control command channel selection	0: Operator keypad 1: External terminal control 2: RS485 Communications port control	0	○	69	101H
E-02	Frequency reference given main channel selection	0: Operator keypad digital given 1: Potentiometer of keypad 2: Terminal VS1 analog voltage 0-10V 3: Terminal AS analog current signal 4-20mA 4: Terminal VS2 analog voltage -10-10V 5: Pulse train signal 6: RS485 communication port 7: Up and Down control 8: General PID operation 9: Constant pressure PID control 10: Program running 11: Swing frequency run 12: Terminal selection:	1	○	69	102H
E-03	Frequency reference given auxiliary channel selection	0: Operator keypad digital 1: Potentiometer of keypad 2: Terminal VS1 analog voltage 0-10V 3: Terminal AS analog current signal 4-20mA 4: Terminal VS2 analog voltage -10-10V 5: Pulse train signal 6: RS485 communication port 7: Up and Down control 8: General PID operation 9: Constant pressure PID control 10: Program running	0	○	71	103H

E-04	Frequency reference given channel gain	0.01-5.00	1.00	○	72	104H
E-05	Frequency reference given channel combination mode	0: Main channel is valid, auxiliary channel is invalid. 1: Auxiliary channel valid, main channel invalid 2: Both channel is valid if non zero value, main channel priority 3: Main channel + K×auxiliary channel) 4: main channel - (K×auxiliary channel) 5: MAX [main channel , (K×auxiliary channel)] 6: MIN [main channel , (K×auxiliary channel)] 7: Auxiliary channel + (K×main channel) 8: Auxiliary channel - (K×main channel) 9: MAX [(K×main channel), auxiliary channel] 10: MIN [(K×main channel), auxiliary channel]	0	○	72	105H
E-06	Upper LED monitor selection	0: Frequency Given 1: Output frequency 2: Output current 3: Input voltage	0	●	72	106H
E-07	Lower LED monitor selection	4: Output voltage 5: Machine speed 6: PID given given 7: PID feedback value	1	●	72	107H
E-08	REV/JOG key of keypad function selection	0: Reverse 1: Jog	0	●	73	108H
E-09	Maximum frequency	0.01-600.00Hz	50.00Hz	○	73	109H
E-10	Upper limit frequency	lower limit frequency - maximum frequency	50.00Hz	●	73	10AH
E-11	Lower limit frequency	0.00-Upper limit frequency	0.00Hz	●	73	10BH
E-12	Lower limit frequency running mode	0: Stop 1: running with lower limit frequency	1	●	73	10CH
E-13	Acceleration time 1	0.1-6500.0s	※	●	74	10DH
E-14	Deceleration time 1	0.1-6500.0s	※	●	74	10EH

E-15	Acceleration /deceleration mode selection	LED unit digit: decelerate /decelerate mode. 0: linear accelerate 1: S curve LED tens digit: Accelerate/decelerate time datum point. 0: Motor rated frequency 1: Maximum frequency LED hundreds digit: Equidistance stop function 0: Disable 1: Enable LED Thousands digit: 0: Disable 1: Enable	0000	●	74	10FH
E-16	Frequency given by digital keypad	lower limit frequency - Upper limit frequency	50.00Hz	●	76	110H
E-17	V/F curve mode	0: Constant torque curve 1: Descend torque curve(1.5 power curve) 2: Descend torque curve(1.7 Power curve) 3: Descend torque curve(2.0 Square curve) 4: User define curve	0	○	76	111H
E-18	Torque boost	0.0%-25.0%	※	●	76	112H
E-19	Filter time constant	0.01-99.99	※	●	77	113H
E-20	Carrier frequency	0.7KHz-15.0KHz	※	●	77	114H
E-21	Carrier characteristic	LED unit Digit: Associate of carrier frequency and output frequency configure. 0: Output frequency associate is disabled. 1: Output frequency associate is enabled. LED tens digit: Associate of carrier frequency and module temperature configure. 0: Module temperature associate is disabled. 1: Module temperature associate is enabled. LED Hundreds digit: PWM mode selection 0: Fixed PWM mode 2: Random PWM mode 1 LED Thousands digit: Inhibition of shock 0: Inhibition of shock is disabled 1: Inhibition of shock is enabled	1010	●	77	115H
E-22	V/F slip compensation	0%-200%	100%	○	78	116H

E-23	Energy saving mode selection	LED unit digit: Auto energy saving selection 0: disable 1: enable LED tens digit: V/F slip compensation 0: Disable 1: Enable LED hundreds digit: reserved LED thousands digit: Overmodulation 0: Overmodulation allow 1: Overmodulation not allow	1000	○	78	117H
E-24	Voltage auto regulation function	0: Disable 1: Enable in full process 2: Disable only in deceleration	2	●	79	118H
E-25	Jog frequency	0.50Hz - upper limit frequency	5.00Hz	●	79	119H
E-26	Jog acceleration time	0.1-6500.0s	2.0s	●	79	11AH
E-27	Jog deceleration time	0.1-6500.0s	2.0s	●	79	11BH
E-28	Starting frequency	0.00-60.00Hz	0.50Hz	○	79	11CH
E-29	Starting frequency holding time	0.0-20.0s	0.0s	○	79	11DH
E-30	Starting mode selection	LED unit digit: Starting mode selection. 0: Starts from starting frequency 1: DC braking first, and then start from starting frequency 2: Restart after speed search LED tens digit: reserved LED Hundreds digit: Speed search direction 0: Speed search performs only in running direction 1: bi-direction speed search LED Thousands digit: Speed search mode 0: Software speed search 1: Hardware speed search	※000	○	80	11EH
E-31	Power off restart selection	0: Disable 1: Enable	0	●	81	11FH
E-32	Power off restart waiting time	0.0-10.0s	0.5s	●	81	120H
E-33	Free stop frequency	0.00-60.00Hz	0.00Hz	●	81	121H
E-34	Stop mode	0: Deceleration stop 1: Free stop	0	●	81	122H
E-35	DC braking current	0-150%	50%	●	82	123H
E-36	DC braking time when stop	0.0-30.0s	0.0s	●	82	124H
E-37	DC braking starting frequency when stop	0.00-60.00Hz	0.00Hz	●	82	125H
E-38	DC braking time when	0.0-10.0s	0.0s	●	82	126H

E-39	Jump frequency 1	0.00-600.0Hz(Fmax)	0.00Hz	●	82	127H
E-40	Jump frequency 2	0.00-600.0Hz(Fmax)	0.00Hz	●	82	128H
E-41	Jump frequency 3	0.00-600.0Hz(Fmax)	0.00Hz	●	82	129H
E-42	Jump frequency range	0.00-5.00Hz	0.00Hz	●	82	12AH
E-43	Number of auto restart attempts	0: Disable 1-3: Enable	0	●	83	12BH
E-44	Fault auto reset waiting time	0.1-20.0s	1.0s	●	83	12CH
E-45	Machine warm up time	0.0-6500s	0.0s	●	83	12DH
E-46	Running direction selection	0: Consistent with the default direction 1: Opposite to the default direction 2: Reverse running forbidden.	0	○	83	12EH
E-47	FOR/REV dead zone time	0.0-10.0s	0.0s	●	84	12FH
E-48	Cooling fans running selection	0: Fan runs when switch on. 1: Fan runs or not relates with temperature during inverter stop mode, fan runs when inverter running. 2.Fan stop during inverter stop mode, running if not relates with temperature during inverter ruing	※	●	84	130H
E-49	Inverter protecting mode selection	LED unit digit: Overvoltage protecting selection during deceleration 0: Disable 1 Enable LED ten digit: Output phase missing protection 0: Disable 1 Enable LED hundred digit: Input phase missing protection 0: Disable 1 Enable LED thousand digit: Inverter overload, over heat protect mode selection. 0: Free stop 1: Running with current limit	0※11	●	84	131H
E-50	Coefficient value of electronic thermal	30%-120% (disable for value less than 30)	0%	●	85	132H
E-51	Stall protecting current limit value	100%-250%	160 G 120 P	●	86	133H
E-52	Stall protecting DC bus voltage threshold value	105-160%	138%	●	86	134H
E-53	Dynamic braking and decelerating over voltage suppression threshold	105-160%	130%	●	86	135H
E-54	Ratio of dynamic braking	0-100%	100%	●	86	136H
E-55	DC bus under voltage protecting value	60-90%	65%	●	87	137H
E-56	reserved				87	138H

E-57	reserved				87	139H
E-58	reserved				87	13AH
E-59	Rotation speed display scale factor	0.1-2000.0%	100.0%	●	87	13BH
E-60	Ratio of inverter output voltage	50-110%	100%	○	87	13CH
E-61	G/P type setting	0: G type 1: P type	0	○	87	13DH
E-62	Speed search stabilizing keeping time	0.200-10.000s	0.600s	●	87	13EH
E-63	Parameters change protection	0: All the parameters changing is allowed 1: Only keyboard digital given parameter changing allowed 2: All the parameters prohibit changing	0	●	88	13FH
E-64	Parameter initialization	0: Null 1: Restores to factory default setting value 2: Clear fault record 3: Transfer parameters of inverter to keypad and save. 4: Transfer parameters saved of keypad to inverter	0	○	88	140H
E-65	Factory password	0-9999	0	●	88	141H
E-66	Information check	LED unit digit: 0: Null operation 1: State monitoring inquiry 2: Fault information inquiry LED ten digit: LCD display language 0:Chinese 1:English	0	●	88	142H
E-67	Interference suppression selection	LED unit digit: Overvoltage interference suppression 0: Disable 1: Enable LED ten digital: SC interference suppression 0: Disable 1: SC interference suppression 1 2: SC interference suppression 2 LED hundred digital: over current interference suppression 0: Disable 1: Over current interference suppression 1 2: Over current interference suppression 2 LED thousand digital: over current in deceleration suppression 0: Disable 1: Enable 2: Enable frequency reducing for protecting over current.	0001	●	92	143H

External terminal parameters

Code function	Function name	Setting range and define	Factory default	property	Refer to page	Communication code
F-01	Input signal selection 1 (X1)	0: Invalid 1: Forward jog operation 2: Reverse jog operation 3: Free stop 4: Fault reset	27	○	93	201H
F-02	Input signal selection2 (X2)	5: Multi steps speed control 1 6: Multi steps speed control 2 7: Multi steps speed control 3 8: Multi steps speed control 4 9: UP/Down running frequency increasing UP	28	○	93	202H
F-03	Input signal selection 3 (X3)	10:UP/Down running frequency decreasing DW 11: Three wire operation control D (X) 12: PID control cancel 13: External fault alarm	1	○	93	203H
F-04	Input signal selection 4 (X4)	14: Acceleration/deceleration time selection terminal 1. 15:Acceleration/deceleration time selection terminal 2 16: Frequency main channel selection terminal 1	2	○	93	204H
F-05	Input signal selection 5 (X5)	17: Frequency main channel selection terminal 2 18: Frequency main channel selection terminal 3 19: Frequency main channel selection terminal 4	3	○	93	205H
F-06	Input signal selection 6 (X6)	20: Program running pause 21: Program restart 22: Timer trigger terminal 23: Timer reset terminal 24: Counter reset terminal 25:Counter clock input terminal 26:Only terminal control channel is enabled selection 27: Forward running 28: Reverse running	4	○	93	206H

F-07	Input signal respond mode selection	<p>LED unit digit: Free stop terminal recover mode 0: Recover to original command with speed search function. 1: Don't recover to original command after free stop terminal disconnecting. 2: Recover to original command without speed search function.</p> <p>LED ten digit: UP and DW terminal control starting frequency setting 0: Runs with UP/DW terminal adjusting without save the frequency record after power loss. 1: Run to last stop moment frequency and then perform UP/DW adjusting. 2: Runs to preset frequency[F-70] first, and then execute UP/DW adjusting.</p> <p>LED hundred digit: STOP/RESE of keypad effective range selection. 0: STOP/RESE key valid only when under keypad control 1: STOP/RESE key valid under any run command source</p> <p>LED thousand digit: Terminal running mode selection after fault reset 0: Start inverter running directly after power on in terminal control mode 1: Stop first and then start in terminal control mode.</p>	0001	○	94	207H
------	-------------------------------------	--	------	---	----	------

F-08	Terminal running control mode	LED unit digit: Terminal control mode selection 0: Standard running control mode 1: 2wire running control mode 2: 2 wire control mode 1 3: 3 wire control mode 2 4: 3 wire control mode 3 5: 3 wire control mode 4 LED ten digit:reserved LED hundred digit:reserved LED thousand: reserved	0000	○	95	208H
F-09	1 step speed setting 1X	0.00Hz-upper limit frequency	30.00Hz	●	97	209H
F-10	2 step speed setting 2X		25.00Hz	●	97	20AH
F-11	3 step speed setting 3X		40.00Hz	●	97	20BH
F-12	4 step speed setting 4X		50.00Hz	●	97	20CH
F-13	5 step speed setting 5X		50.00Hz	●	97	20DH
F-14	6 step speed setting 6X		40.00Hz	●	97	20EH
F-15	7 step speed setting 7X		25.00Hz	●	97	20FH
F-16	8 step speed setting 8X		10.00Hz	●	97	210H
F-17	reserved				98	211H
F-18	reserved				98	212H
F-19	Speed search tracking speed	0.1-10.0%	0.2%	○	98	213H
F-20	Voltage stores time	0.10S-10.00S	0.60s	○	98	214H
F-21	Speed search respond current threshold value	10%-200%	120%	○	98	215H
F-22	Frequency reducing acceleration time	0.1-6500.0s	2.0s	●	98	216H
F-23	Frequency reducing acceleration time	0.1-6500.0s	0.3s	●	98	217H
F-24	Acceleration time 2	0.1-6500.0s	※	●	99	218H
F-25	Deceleration time 2		※	●	99	219H
F-26	Acceleration time 3		※	●	99	21AH
F-27	Deceleration time 3		※	●	99	21BH
F-28	Acceleration time 4		※	●	99	21CH
F-29	Deceleration time 4		※	●	99	21DH

F-30	Relay output terminal (TA,TB,TC)	0: Zero frequency (standby state) 1: Fault alarm 1. (Including fault auto reset period.) 2: Fault alarm 2. (Not includes fault auto reset period.) 3: Frequency arriving detection 4: Frequency level detection 5: Running statuses 6: Reverse running 7: Under voltage of inverter 8: Overload pre-alarm 9: Output frequency reach upper limit frequency 10. Output frequency reach lower limit frequency 11. External fault stop 12. Timer times up	1	●	99	21EH
F-31	Output terminal Y1	13. Counter reach maximum values 14. Counter reach setting values 15. PID feedback upper limit alarm 16. PID feedback lower limit alarm 17. Sensor broken 18.Program running cycle completed 19.Program running step completed 20:Dynamic braking processing	4	●	99	21FH
F-32	Output terminal Y2	21: Output terminal control by external 22. Fault alarm 1. (Including fault auto reset period,inclusing fault-LU1)	7	●	99	220H
F-33	Frequency arriving detect bias	0.00-50.00Hz	1.00Hz	●	101	221H
F-34	Output frequency level detection	0.00-600.0Hz	30.00Hz	●	101	222H
F-35	Output frequency level detecting relay time	0.0-20.0s	0.0s	●	101	223H
F-36	Overload pre-alarm level	50-200%	150%	●	101	224H
F-37	Overload pre-alarm delay time	0.0-20.0s	1.0s	●	101	225H
F-38	Timer setting value	1-65000s	1s	●	101	226H
F-39	Counter maximum value	1-65000	1000	●	102	227H
F-40	Counter setting value	1- Counter maximum value	100	●	102	228H

F-41	VS1 terminal input voltage lower limit	0.00V- [F-42]	0.50V	●	102	229H
F-42	VS1 terminal input voltage upper limit	[F-41]-10.00V	9.50V	●	102	22AH
F-43	VS1 terminal input voltage gain	0.01-5.00	1.00	●	102	22BH
F-44	VS2 terminal input voltage lower limit	-10.0V –[F-45]	0.5V	●	102	22CH
F-45	VS2 terminal input voltage upper limit	[F-44]-10.0V	9.5V	●	102	22DH
F-46	VS2 terminal input voltage gain	0.01-5.00	1.00	●	102	22EH
F-47	VS2 terminal input voltage lower limit	-1.00V-1.00V	0.00V	●	102	22FH
F-48	VS2 terminal input bipolar adjust and direction control	0: Bipolar adjust and direction control both invalid 1: Bipolar adjust and direction control both valid 2: Bipolar adjust valid, direction control invalid	0	●	102	230H
F-49	VS2 terminal input bipolar control zero hysteresis band	0.00V-3.00V	0.20V	●	103	231H
F-50	AS terminal input current lower limit	0.00mA - [F-51]	4.20mA	●	104	232H
F-51	AS terminal input current upper limit	[F-50] - 20.0mA	19.50mA	●	104	233H
F-52	AS terminal input current gain	0.01-5.00	1.00	●	104	234H
F-53	Pulse input frequency lower	0.00KHz- [F-54]	0.00KHz	●	105	235H
F-54	Pulse input frequency upper limit	[F-53] - 50.00KHz	10.00KHz	●	105	236H
F-55	Pulse input frequency gain	0.01-5.00	1.00	●	105	237H
F-56	Input lower limit correspond setting	0.00Hz - [F-57]	0.00Hz	●	105	238H
F-57	Input upper limit correspond setting frequency	[F-56] - maximum frequency	50.00Hz	●	105	239H

F-58	Input signal characteristic selection	LED unit digit: VS1 input characteristic selection 0: Positive characteristic 1: Negative characteristic LED ten digit: AS input characteristic selection 0: Positive characteristic 1: Negative characteristic LED hundred digit: VS2 input characteristic selection 0: Positive characteristic 1: Negative characteristic LED thousand digit: Pulse input characteristic selection 0: Positive characteristic 1: Negative characteristic	0000	●	105	23AH
F-59	Terminal analog input filtering time constant	0.01-5.00	0.50	●	106	23BH
F-60	Output terminal (AO1) selection	0: Output signal disable 1: Output frequency/speed 2: Output current 3: Given frequency/speed reference	1	●	106	23CH
F-61	Output terminal (AO2) selection	4: PID given value 5: PID feedback value 6: DC bus voltage 7: Output voltage	3	●	106	23DH
F-62	Analog output signal selection	LED unit digit: A02 output signal mode selection 0: Frequency pulse train output 1: 0-20mA 2: 4-20mA 3: 0-10V LED ten digit: A01 output signal mode selection 0: 0-10V 1: 0-20mA 2: 4-20mA LED hundred digit: reserved LED thousand digit: reserved	0003	●	107	23EH
F-63	AO1 output signal gain	25%-200%	100%	●	107	23FH
F-64	AO2 output signal gain	25%-200%	100%	●	107	240H
F-65	AO1 output signal zero adjust	-10.0%-10.0%	0.0%	●	107	241H
F-66	AO2 output signal zero adjust	-10.0%-10.0%	0.0%	●	107	242H

F-67	Keyboard potentiometer Input voltage lower limit	0.00V - [F-68]	0.20V	●	107	243H
F-68	Keyboard potentiometer Input voltage upper limit	[F-67] - 5.50V	4.80V	●	107	244H
F-69	Keyboard potentiometer gain	0.00-5.00	1.00	●	107	245H
F-70	UP/DW terminal preset frequency	0.00Hz - upper limit frequency	0.00Hz	●	108	246H
F-71	UP/DW Power-off memorized frequency	0.00Hz - upper limit frequency	0.00Hz	○	108	247H

Special function parameters

Code function	Function name	Setting range and define	Factory default	pr op er ty	Refe r to page	Comm unicati on code
H-01	User setting voltage V1	0.0% -[H-03]	3.0%	○	108	301H
H-02	User setting frequency F1	0.0Hz-[H-04]	1.00Hz	○	108	302H
H-03	User setting voltage V2	[H-01-H-05]	28.0%	○	108	303H
H-04	User setting frequency F2	[H-02-H-06]	10.00Hz	○	108	304H
H-05	User setting voltage V3	[H-03-H-07]	55.0%	○	108	305H
H-06	User setting frequency F3	[H-04-H-08]	25.00Hz	○	108	306H
H-07	User setting voltage V4	[H-05-H-09]	80.0%	○	108	307H
H-08	User setting frequency F4	[H-06-H-10]	37.50Hz	○	108	308H
H-09	User setting voltage V5	[H-07]-100.0%	100.0%	○	108	309H
H-10	User setting frequency F5	[H-08]-maximum frequency	50.00Hz	○	108	30AH
H-11	PID output characteristic	0: Positive characteristic 1: Negative characteristic	0	○	109	30BH
H-12	PID controller given signal sources	0: Keypad potentiometer 1: PID keypad digital given 2: External terminal VS1:0-10V 3: External terminal AS: 4-20mA 4: External terminal VS2 5: External pulse signal 6: RS485 interface	1	○	109	30CH
H-13	PID controller feedback signal source	0: External terminal VS1:0-10V 1: External terminal AS: 4-20mA 2: External terminal VS2 (bipolar invalid) 3: External pulse signal	1	○	109	30DH
H-14	PID preset frequency	0.00Hz-upper limit frequency	0.00Hz	○	110	30EH
H-15	PID preset frequency running time	0.0-6500.0s	0.0s	●	110	30FH
H-16	PID keypad digital given	0.0-100.0%	50.0%	●	110	310H
H-17	PID channel gain	0.01-5.00	1.00	●	110	311H

H-18	Sensor maximum measuring range	1.0-100.0	100.0	●	110	312H
H-19	Proportion gain P	0.1-100.0	20.0	●	111	313H
H-20	Integral time constant I	0.1-100.0s	2.0s	●	111	314H
H-21	Differential gain D	0.0-10.0	0.0	●	111	315H
H-22	Sampling period	0.01-60.00s	0.10s	●	111	316H
H-23	PID control deviation limit	0.0-20.0%	0.0%	●	111	317H
H-24	Starting threshold value	0.0%-Sleep threshold value	0.0%	●	111	318H
H-25	Sleep threshold value	Starting threshold value-100.0%	100.0%	●	111	319H
H-26	Alarm upper limit value	Alarm lower limit value-100.0%	100.0%	●	112	31AH
H-27	Alarm lower limit value	0.0%-Alarm upper limit value	0.0%	●	112	31BH
H-28	Sensor disconnection detection	0.0-20.0%	0.0%	●	112	31CH
H-29	Sensor disconnection alarm operation selection	0: continue running 1: Stop	0	●	112	31DH
H-30	Upper limit threshold	lower limit threshold-100.0%	100.0%	●	112	31EH
H-31	Lower limit threshold	0.0%-Upper limit threshold	0.0%	●	112	31FH
H-32	Program running mode	0: Single cycle running (time by second) 1: Continuous cycle running 2: single cycle, continuous running (time by second) 3: Single cycle running (time by minute) 4: Continuous cycle (time by minute) 5: Single cycle, continuous running (time by minute)	0	○	112	320H
H-33	Program run breakpoint restore mode selection	0: Running at the first step speed 1: Continue to run with breakpoint running frequency and retiming. 2: Continue to run with the breakpoint running frequency and residual time.	0	○	114	321H
H-34	Program running state power down memory selection	0: NO power down memory 1: power down memory	0	○	114	322H
H-35	1 step speed direction and accel/decel time	0: Forward; Acceleration time 1/Deceleration time 1	0	●	114	323H
H-36	2 step speed direction and accel/decel time	1: Forward; Acceleration time 1/Deceleration time 2	1	●	114	324H
H-37	3 step speed direction and accel/decel time	2: Forward; Acceleration time 1/Deceleration time 3	2	●	114	325H
H-38	4 step speed direction and accel/decel time	3: Forward; Acceleration time 1/Deceleration time 4	3	●	114	326H
H-39	5 step speed direction and accel/decel time	4: Reverse; Acceleration time 1/Deceleration time 1	4	●	114	327H

H-40	6 step speed direction and accel/decel time	5: Reverse; Acceleration time 1/Deceleration time 2	5	●	114	328H
H-41	7 step speed direction and accel/decel time	6: Reverse; Acceleration time 1/Deceleration time 3	6	●	114	329H
H-42	8 step speed direction and accel/decel time	7: Reverse; Acceleration time 1/Deceleration time 4	7	●	114	32AH
H-43	1 step speed running time T1	0.0-6000s(min)	10.0	●	115	32BH
H-44	2 step speed running time T2		10.0	●	115	32CH
H-45	3 step speed running time T3		10.0	●	115	32DH
H-46	4 step speed running time T4		10.0	●	115	32EH
H-47	5 step speed running time T5		10.0	●	115	32FH
H-48	6 step speed running time T6		10.0	●	115	330H
H-49	7 step speed running time T7		10.0	●	115	331H
H-50	8 step speed running time T8		10.0	●	115	332H
H-51	Differential frequency Δf in swing frequency	0.00-20.00Hz	2.00Hz	●	115	333H
H-52	Motor rated power	0.4-1100.0KW	※	○	115	334H
H-53	Motor rated frequency	0.00-600.00Hz	50.00Hz	○	115	335H
H-54	Motor rated speed	0-18000RPM	※	○	116	336H
H-55	Motor rated voltage	0-1500V	※	○	116	337H
H-56	Motor rated current	0.1-1000.0A	※	○	116	338H
H-57	Motor no load current	0.01-650.00A	※	○	116	339H
H-58	Motor stator resistor	0.001-65.000Ω	※	○	116	33AH
H-59	Motor rotator resistor	0.001-65.000Ω	※	●	116	33BH
H-60	Motor stator inductance	0.1-6500.0mH	※	●	116	33CH
H-61	Motor rotator mutual inductance	0.1-6500.0mH	※	●	116	33DH
H-62	Motor auto tuning selection	0: Null operation. 1: Rotational motor auto tuning. 2: Stationary auto tuning	0	○	116	33EH
H-63	Motor magnetic saturation coefficient 1	0-9999	※	●	116	33FH
H-64	Motor magnetic saturation coefficient 2	0-9999	※	●	116	340H

H-65	Motor magnetic saturation coefficient 3	0-9999	※	●	116	341H
H-66	Linkage main station setting	0: Local machine configure as linkage slave station 1: Main station control mode 1. 2: Main station control mode 2.	0	●	117	342H
H-67	Local inverter address	1-247	1	●	117	343H
H-68	Data format	0: No check (N,8,1) 1: Even parity check(E,8,1) 2: Odd parity check (O,8,1) 3: No check (N,8,2)	3	○	117	344H
H-69	Baud rate	0: 1200bps 1: 2400bps 2: 4800bps 3: 9600bps 4: 19200bps 5: 38400bps	3	○	117	345H
H-70	Communication setting frequency ratio	0.00-20.00	1.00	●	117	346H
H-71	Time of communication time out	0.0-6500.0s	10.0s	●	117	347H
H-72	RS485 communication broken responding mode	LED“0” digit: RS485 communication broken responding mode 0: Give alarm and free stop 1.No alarm and continue running 2.No alarm but stop LED “00” digit: Communication write operation mode. 0: Reply for write operation 1: No reply for write operation LED “000” digit:: reserved LED “0000” digit: reserved	0001	●	117	348H
H-73	Respond relay	0.000-1.000s	0.005s	●	118	349H
H-74	Instantaneous stop decel. respond voltage lower limit	0%-200%	20%	●	118	34AH
H-75	Instantaneous stop decel. respond voltage upper limit	0%-200%	90%	●	118	34BH
H-76	Instantaneous stop decel. gain	0.01-10.00	2.00	●	118	34CH
H-77	Voltage recover stability time	0.0-100.0s	2.0s	●	118	34DH
H-78	Torque compensation upper limit	0.00-60.00%	50.00%		118	34EH
H-79	Output terminal external control status	0-9999	0	●	118	34FH
H-80	Reserved				118	350H

Appendix 2: RS485 Communication Protocol

1 Communication Protocol

AC70 series frequency inverter can select the RS485 communication interface. The international standard ModBus communication protocol is adopted for master-slave communication. The consumer can carry out centralized control by PC/PLC, upper machine, main station frequency inverter etc (Setting of the frequency inverter control command, running frequency, relative function parameters modification, frequency inverter working state and malfunction information monitoring etc.. to adapt to the special application requirements.

2 Protocol Content

This ModBus protocol defines the information content and format of asynchronous transmission in series communication. It includes: host machine polling, broadcast and the format of slave machine response. Host machine data frame includes: slave machine address (or broadcast address), ask action code, data and fault check. Slave machine response is same structure: action check, back data and fault check. If slave machine meet fault while accept frame, or can't compete the action asked, fault information will be feed back to host machine.

3 Application Mode

AC70 series frequency inverter controls network for "single host machine and many slave machines" with RS232/RS485.

Remote RS485 communication needs shield cable and shield grounding.

For long distance communication, we suggest to open J6 and add 120 Ω resistance to prevent signal reflection.

4 Main Line Structure

- 1, Port mode: RS485 port
- 2, Transmission mode: Asynchronous series, half duplex transmission mode. At same time, one of the host machine and slave machine sends data, another receives data. Data is sent one by one frame as report form in asynchronous series communication.
- 3, Topological structure: One host machine with several slave machines. Range of slave machine address is 1 to 247. 0 is broadcast address. Every slave machine address is only one. It is the base of ModBus series communication.

5 Protocol Explain

AC70 series frequency inverter communication protocol is main-slave ModBus communication protocol of asynchronous series. In the net, only the host machine can set up protocol "inquire/ order". Slave machines can only respond to host machine. Host machine means PC, main frequency inverter, industrial control equipment or PLC... Slave machines are AC70 frequency inverters and other control equipments with same communication protocol. Host machine can communicate with only one slave machine or broadcast to all slave machines. Slave machine need feedback every "inquire/order" of host machine, but no need feedback broadcast.

5.1 Communication frame structure

The ModBus protocol communication data format of AC70 series frequency inverter is RTU (remote terminal unit) mode. Communication data format is as follows:

The byte composition: Include initiation bit, 8 data bit, check bit and stop bit.

Initiation bit	Bit1	Bit2	Bit3	Bit4	Bit5	Bit6	Bit7	Bit8	No check bit	stop bit
									Even check bit	
									Odd check	

In RTU mode, it always starts after at least 3.5 byte transmission time which is easy realized under Baud rate. And next data is: slave machine address, operation order code, data and CRC check. Every domain transmission is hexadecimal 0...9, A...F. Network equipment detects the network bus unceasingly, including the interval time. While receiving the first domain (address information, each network equipments carry out decoding to judge whether the byte is for itself. While the final byte transmission is completed, there will be at least 3.5 bytes transmission time interval to indicate that this frame is over. Then a new information' transmission can begin



One frame message must be transmitted as a continued data flow. If there is a pause over 1.5 byte before the end, the receiving equipment will clear the half-baked information. And the next byte will be considered as the address domain of

a new frame. Similarly, if the interval between a new frame start-up and the former frame is smaller than 3.5 byte time, the receiving equipment will think that it is the former one frame continuation. Because of the jumbled frame, finally CRC checking value is incorrect, what leads to the communication mistake.

RTU frame's standard structure:

Frame START	Transmission time of 3.5 bytes
Slave machine address	Communication address: 0~247(decimal)(0 is broadcast address)
Function code CMD	03H:read slave machine parameter 06H: write slave machine parameter 08H:circuit auto-detection
Data domain DATA (N-1) ... DATA (0)	parameter address, parameter number, parameter values ,
CRC CHK low-order	Detecting value:16 bit CRC check value
CRC CHK high-order	
Frame ending	transmission time of 3.5 bytes

5.2 Order code and communication data description

5.2.1 Order code:03H, read N word (can continue reading 5 words at most)

For example:A frequency inverter who is slave machine with address 01 H and memory initial address 0101H([E-01]) reads 3 words continuously. Then the structure of that frame is described as follows:

RTU host machine order information

START	Transmission time of 3.5 bytes
Slave machine address	01H
Order code	03H
Start address high-order	01H
Start address low-order	01H
Data number high-order	00H
Data number low-order	03H
CRC CHK low-order	55H
CRC CHK high-order	F7H
END	Transmission time of 3.5 bytes

RTU Slave machine responding information (normal)

START	Transmission time of 3.5 bytes
Slave machine address	01H
Order code	03H
Byte number low-order	06H
Data address 0101H high-order	00H
Data address 0101H low-order	02H
Data address 0102H high-order	00H
Data address 0102H low-order	00H
Data address 0103H high-order	00H
Data address 0103H low-order	06H
CRC CHK low-order	D8H
CRC CHK high-order	B7H
END	Transmission time of 3.5 bytes

RTU Slave machine responding information (abnormal)

START	Transmission time of 3.5 bytes
Slave machine address	01H
Order code	83H
Error code	04H
CRC CHK low-order	40H
CRC CHK high-order	F3H
END	Transmission time of 3.5 bytes

5.2.2 Order code:06H, write a Word.

Function: write a word data in the designated data address. It can be used to revise the frequency inverter parameters.

For example: 5000 (1388 H. is written into 0110H ([E-16]) address of slave frequency inverter with address 02H. Then the structure of this frame is described as follows:

RTU host machine order information

START	Transmission time of 3.5 bytes
Slave machine address	02H
Order code	06H
Write data address high-order	01H
Write data address low-order	10H
Data content high-order	13H
Data content low-order	88H
CRC CHK low-order	84H
CRC CHK high-order	96H
END	Transmission time of 3.5 bytes

RTU Slave machine responding information (normal)

START	Transmission time of 3.5 bytes
Slave machine address	02H
Order code	06H
Write data address high-order	01H
Write data address low-order	10H
Data content high-order	13H
Data content low-order	88H
CRC CHK low-order	84H
CRC CHK high-order	96H
END	Transmission time of 3.5 bytes

RTU Slave machine responding information (abnormal)

START	Transmission time of 3.5 bytes
Slave machine address	02H
Order code	86H
Error code	01H
CRC CHK low-order	73H
CRC CHK high-order	A0H
END	Transmission time of 3.5 bytes

5.2.3 Order code:08H, circuit auto-detection

Function: Send back the slave machine responding information which is identical with the host machine command information. It is used to check whether the signal transmission between the host machine and slave machine is regular or not. The checking code and the data can be set freely.

RTU Host machine command information

START	Transmission time of 3.5 bytes
Slave machine address	01H
Order code	08H
Detecting code high-order	00H
Detecting code low-order	00H

Data high-order	13H
Data low-order	88H
CRC CHK low-order	EDH
CRC CHK high-order	5DH
END	Transmission time of 3.5 bytes

RTU Slave machine responding information (normal)

START	Transmission time of 3.5 bytes
Slave machine address	01H
Order code	08H
Detecting code high-order	00H
Detecting code low-order	00H
Data high-order	13H
Data low-order	88H
CRC CHK low-order	EDH
CRC CHK high-order	5DH
END	Transmission time of 3.5 bytes

RTU Slave machine responding information (abnormal)

START	Transmission time of 3.5 bytes
slave machine address	01H
Order code	88H
Error code	03H
CRC CHK low-order	06H
CRC CHK high-order	01H
END	Transmission time of 3.5 bytes

5.2.4 Communication frame error check mode

The standard ModBus serial network adopts two kinds of error check mode: odd/even checking which is used to check every character and CRC detecting which is used to check one frame of data.

1, Odd-even checking

The users can configure the controller with odd or even checking, or no checking, what will determine how to set odd/even checking in every character.

If odd/even checking have been allocated, "1" bit will be accounted to the bit number of each character (7 bits in ASCII mode, 8 bits in RTU.. For example, the RTU character frame contains the following 8 bits: 1 1 0 0 0 1 0 1

There are 4 bits with number"1". If using the even checking, odd/even checking bit of the frame will be 0, then there are still 4 bits with number"1". If using odd checking, odd/even checking bit of the frame will be 1. Then there are 5 bits with number"1".

If odd/even checking has not been allocated, there will be no checking bit during the transmission, and no checking detection. One additional stop bit will be filled into the character frame in transmission.

2, CRC-16(cycle redundant check)

While the RTU frame form in use; the frame has included the frame error detecting domain which calculates base on the CRC method. The CRC domain checks the content of the entire frame. The CRC domain is two bytes, containing binary values of 16 bits. It is added to the frame after calculated by the transmission equipment. The receiving equipment calculates CRC who receives frame again, and compares it with the value of the receiving CRC domain. If both CRC value are not equal, it means the transmission has mistake. CRC is firstly stored in 0xFFFF. Then a program is used to process the continuous 6 or above bytes in the frame and the value of current registers. Only 8Bit in every character is valid to CRC. Start bit、stop bit and parity check bit are invalid.

In the process of CRC coming out, each 8 characters independently XOR with register content. The result moves to minimum effective digit. LSB is extracted to be detected. If LSB is 1, the register is independently XOR with the pre-set value. If LSB is 0, it is no XOR. This process needs to repeat 8 times. After the last bit (the eighth bit. is accomplished. Next 8 bits bytes will independently XOR with register content. All the final bytes in the frame are CRC value after processed.

This CRC operation method adopts the international standard CRC checking rule. Users can consult the relevant standard CRC operation while editing the CRC algorithm to compile out the real CRC calculation program as required.

Now here provide the user a simple CRC operation function (with C language programming):

```
unsigned int crc_chk_value(unsigned char *data_value,unsigned char length)
{
```

```

unsigned int crc_value=0xFFFF;
int i;
while(length-->0)
{
    crc_value^=*data_value++;
    for(i=0;i<8;i++)
    {
        if(crc_value&0x0001)
        {
            crc_value=(crc_value>>1)^0xa001;
        }
        else
        {
            crc_value=crc_value>>1;
        }
    }
}
return(crc_value);
}

```

5.2.5 Communication data address definition

It is used to control frequency inverter operation, get state information and parameter setting of frequency inverter.

(1.AC70 serial function parameter address express rules

Take frequency inverter function parameter serial numbers as register address which are divided into the high byte and the low byte two parts. The high byte expresses the function parameter group serial numbers. The byte expresses the inner serial numbers of each function parameter group. All need to be changed to hexadecimal.

Address domain high byte definition:

- x1xxH:basic parameter group (E group)
- x2xxH:external terminal parameter group(F group)
- x3xxH:dedicated function parameter group (H group).
- xCxxH: monitoring parameter group (C group).
- xExxH: fault information group (ER group).

Attention: due to possibility that the parameters are frequently rewritten exists in the communication, EEPROM are frequently stored. So its lifetime is cut down. As for the consumer, some function is unnecessarily to store in the communication mode, only require to changing the value of RAM inner, can satisfy the usage requirement. As AC70 communication protocol stipulates, when it use writing order (06 H), if the parameter function code address domain highest digit is 0, merely write in the frequency inverter RAM, power down without storing, if the parameter function code address high half digit is 1, write in EEPROM, namely power off with storing.

For example, rewriting the function parameter [E-16], not depositing to EEPROM, address expresses for 0110H, depositing to EEPROM, address expresses for 1110H.

Only write in the frequency inverter RAM, power down without storing.

START	Transmission time of 3.5 bytes
Slave machine address	02H
Order code	06H
Write data address high-order	01H
Write data address low-order	10H
Data content high-order	13H
Data content low-order	88H

CRC CHK low-order	84H
CRC CHK high-order	96H
END	Transmission time of 3.5 bytes

Write in EEPROM, power off with storing.

START	Transmission time of 3.5 bytes
Slave machine address	02H
Order code	06H
Write data address high-order	11H
Write data address low-order	10H
Data content high-order	13H
Data content low-order	88H
CRC CHK low-order	84H
CRC CHK high-order	96H
END	Transmission time of 3.5 bytes

(2) Other communication parameter address specification:

Function	Address	Explain	R/W trait		
Communication give frequency	3000H	Communication give frequency, power down without storing	W/R		
Communication order setting	3001H	0000H: No command	W		
		0001H: FWD			
		0002H: REV			
		0003H: Forwarder JOG			
		0004H: Reverse JOG			
		0005H: Decelerate to stop			
		0006H: Free stop			
Frequency inverter state	3002H	Bit0	0: Stop	1:WORKING	R
		Bit1	0: Not ACC	1:ACC	
		Bit2	0: Not DEC	1:DEC	
		Bit3	0: FWD	1:REV	
		Bit4	0: Normal	1:Fault	
Fault code	3003H	Fault code (See fault code table)	R		

Appendix 3: LCD Keyboard Manual

1 Function Characteristic

LCD keyboard is designed for user checking function parameters more directly. Language of LCD keyboard includes English and Chinese, and is compatible with other LED keyboard designed by our company.

It can display two monitoring parameters at the same time when inverter stops or runs.

States of running, stop and fault all have vivid image that makes user to understand and remember states of inverter more conveniently.

It also has parameter copy and download functions, and can download parameters of same series inverter. It is convenient for user to change batch parameters.

Potentiometer is also on the keyboard and used for changing given frequency.

Note:

1. If special type inverter needs LCD keyboard, please contact with our company.
2. User must confirm that type of LCD keyboard and type of inverter are suited.

Software version of LCD	Type of inverters
KB10B	AC70
KB30B	AC80B
KB50B	AC80C
KB70B	AC100

2 Monitor Menu

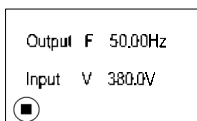

Chart 1 (a) at stop state

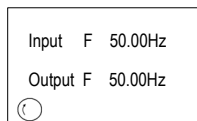

Chart1 (b) at FWD running state

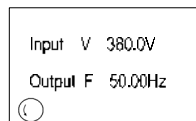

Chart1 (c) at REV running state

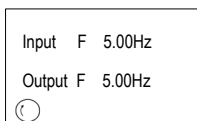

Chart1 (d) at JOG FWD state

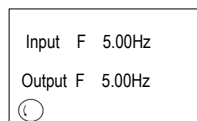

Chart1 (e) at JOG REV state

It can display two monitoring parameters and running or stop status every state of inverter, details refer to chart 1. User can select first-line monitoring parameters by **SET**, and select second-line monitoring parameters by **<<**.

3 Monitoring Parameter Menu

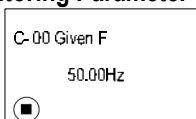

Chart 2 Monitoring menu

Please press **PRG** key long time for 1s, then it will go into monitoring menu as chart 2. And user can check parameters by **▲** or **▼** key, pressing **PRG** or **SET** key to return back.

4 Parameters Menu

(1) First level menu (Reserve)

(2) Second level menu

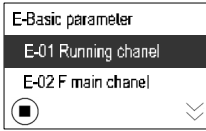

Chart 3(a) Basic parameter

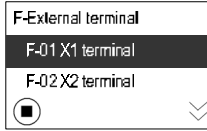

Chart 3(b) External terminal

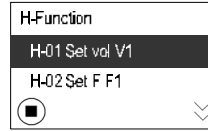

Chart 3(c) Function parameter

The second level menu include 3 part: Basic parameter, External terminal, Function parameter, as show in chart 3. Press **PRG** key and enter into 3(a).User can select anyone of them by press **▲** or **▼** key. Press **SET** key means selecting the item, And Press **PRG** key to move monitoring interface, Basic parameter, External terminal, Function parameter these 4 inverter face circular by turn.

(3) Third level menu

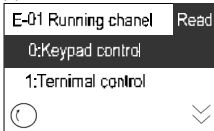

Chart 4 (a) changing line

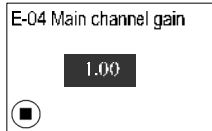

Chart 4 (b) data

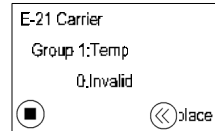

Chart 4 (c) group

After going into second level menu, press **PRG** key to go into third level menu. Third level menu includes three kinds, changing line, data and group.

Changing line: First line displays second level items, second and third line display third level items, and position of cursor is factory default setting, details refer to chart 4(a).

Press **◀** key to replace items,

Press **▲** or **▼** to move cursor,

Press **PRG** to return back,

Press **SET** to select item, and then return back.

Data: First line displays second level menu items, and second line displays data ,details refer to chart 4(b)

Press **◀** to replace items,

Press **▲** or **▼** to increase or decrease data while pressing **◀**, Press **▲** or **▼** to increase or decrease data from lowest bit without pressing **◀**,

Press **PRG** to return back.

Press **SET** to confirm modifying data, and then return back.

Group: First line displays second level menu items, second line displays group number, and third line displays third level menu items, details refer to chart 4(c)

Press **◀** to change another group, Press **▲** or **▼** to change items,

Press **PRG** key to return back.

Press **SET** to confirm modifying items, and then return back.

If pressing **▲** or **▼** cannot modify items in third level menu, and display "Read only" all that reminder user of parameter is no t allowed to modify or when inverter is running ,modifying is forbidden

5 Fault

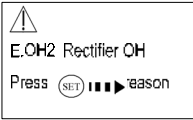

Chart 5 (a) fault

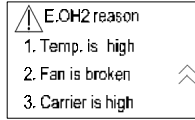

Chart 5 (b) fault reason

Fault: First line displays fault icon shining, second line displays fault code and name, and third line reminder user of pressing **[SET]** to check fault reasons, details refer to chart 5(a). Press **[SET]** to go into fault reason.

Press **[STOP/RESET]** to reset fault when fault has been cleared

Fault reason: First line displays fault icon、code and name, other lines display reasons, details please refer to chart 5(b).If there up or down arrows, please press **[▲]** or **[▼]** to change another page to check reasons, Press **[PRG]** or **[SET]** to return back

6 Terminal State

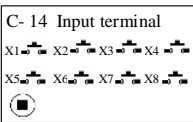

Chart 6 (a) input terminal

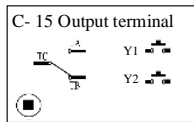

Chart 6 (b) output terminal

Input terminal: details please refer to chart 6(a)

Output terminal: details please refer to char 6(b)

Note: If monitoring items are both terminal state in both lines, it will displays input terminal firstly.

7 Parameters Copy

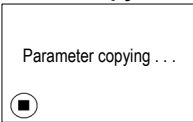

Chart7 (a) copying

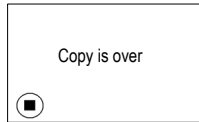

Chart7 (b) copy complete

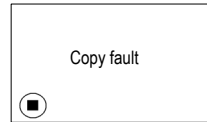

Chart7 (c) copy fault

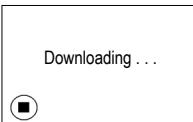

Chart7 (d) download

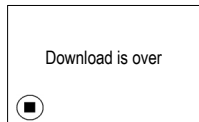

Chart7 (e) download complete

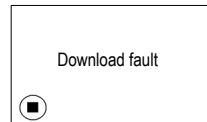

Chart7 (f) download fault

Parameter copy: details please refer to chart 7 (a), 7(b), 7(c)

Check E-64 and select item "sending to keyboard from inverter",and then press **[SET]**.When it displays "completely copy ", it means finishing copy operation details refer to chart 7 (b) .When it displays "copy fault" ,it means operation is failed, details please refer to chart 8(c).Press **[PRG]** key to return .

Download: same way as copy

Note:Inverters must be the same series , when downloading parameters

8 Self-tuning

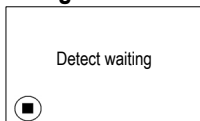

Chart 8 (a) waiting

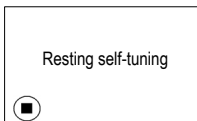

Chart 8 (b) resting type self-tuning

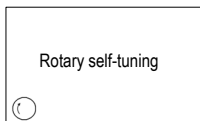

Chart 8 (c) rotary type self-tuning

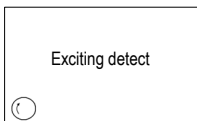

Chart 8(d) exciting magnetic detecting

Resting type self-tuning: steps as chart 8 (a), (b) and (d). Please set H-62=2, and press **SET** key to go into motor detecting waiting menu, details refer to chart 8(a). Then press **FWD** key, and it will display resting self-tuning, details refer to 8(b). It displays "exciting detecting" when self-tuning is over, details refer to chart 9(d), then it will return back automatically.

Rotary self-tuning: steps as chart 8 (a),(b)and (d). Please set F-62=1, and press **SET** key to go into motor detecting waiting menu, details refer to chart 8(a). Then press **FWD** key, and it will display resting self-tuning, details refer to 8(b), while resting self-tuning is over, it displays rotary self-tuning, details refer to chart8(c). After rotary self-tuning over, it displays exciting detecting, details refer to chart 8(d), then it will return back automatically.

9 Other Menus

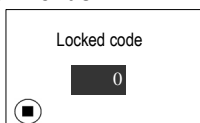

Chart 9 (a) keyboard locked

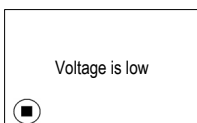

Chart 9 (b) low voltage

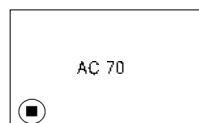

Chart 9 (c) model of inverter

Keyboard locked, as chart 9(a). Keyboard will display locked menu when going into next menu, after user setting password and selecting parameter locked function. Please type correct password and then go into next menu.

Low voltage, as chart 9(b). When input voltage is low, it will display this warning.

Model of inverter, as chart 9(c). When power on, if communication is ok, it will display this menu, and if not, it will display keyboard connection fault.

Warranty Card

Profile

User Name : _____

Address : _____

Contacts : _____ Phone : _____ Fax : _____

Model : _____ Machine Code : _____

Agent/Distributor Profile

Delivery Company : _____

Contacts : _____ Phone : _____ Delivery Date : _____

Warranty Clauses

The Company solemnly states that since the day users purchase from my company (hereinafter referred to as manufacturer),they can enjoy the following warranty services;

- 1.Since the date of purchase, users can enjoy the following warranty services of the product:
 - 1) Within 30 days after shipment,the company promises returning,replacement and maintenance of the product.
 - 2) Within 90 days after shipment,the company promises replacement and maintenance of the product.
 - 3) Within 18 months after shipment,the company promises only maintenance of the product.
 - 4) Products exported to countries except China shall not enjoy the warranties mentioned above.
2. Since the date of purchase, users can enjoy the service of the company when they pay for the service.
3. Exception Clauses: Product failures caused by the following reasons would not enjoy the free warranty services of the manufacturer:
 - 1) Failures caused by operations of users that is not operated in accordance with the requirements of the product manual;
 - 2) Failures caused when users repair or renovate the product without communicating with the manufacturer in advance;
 - 3) Failures caused by abnormal aging of the product resulted from poor using environment;
 - 4) Failures caused by earthquake, fire or other natural disasters or abnormal voltage;
 - 5) Failures caused by damage during transportation(mode of transportation is decided by users and the company only helps to handle cargo shipment procedures).
4. In the following conditions, the manufacturer have the right not to provide warranty services:
 - 1) When the marks,trademarks or nameplates of the products are destroyed or can not be identified;
 - 2) When users do not pay for the product according to signed contract;
 - 3) When users intentionally hiding the improper operations during installation, wiring and maintenance;
5. For products that enjoy all returning,replacement and maintenance services, first the product should be returned to the company and after responsibility confirmation,the product can be replaced or repaired.

Certificate of Approval

QC check : _____



The product has been checked and proved to be qualified for delivery in conformity with standard.